



BROADCAST POWER MONITOR
SERIES BPM-E

MODEL 3129 DIGITAL DISPLAY

OPERATION MANUAL

©COPYRIGHT 2016 BY BIRD TECHNOLOGIES, INC.
INSTRUCTION BOOK P/N 920-7005ABPME REV. J
THRULINE® IS A REGISTERED TRADEMARK OF
BIRD ELECTRONIC CORPORATION
MICROSOFT® AND WINDOWS® ARE REGISTERED
TRADEMARKS OF THE MICROSOFT CORPORATION
JAVA® IS A REGISTERED TRADEMARK OF SUN MICROSYSTEMS, INC.

Safety Precautions

The following are general safety precautions that are not necessarily related to any specific part or procedure, and do not necessarily appear elsewhere in this publication. These precautions must be thoroughly understood and apply to all phases of operation and maintenance.

WARNING

Keep Away From Live Circuits

Operating Personnel must at all times observe general safety precautions. Do not replace components or make adjustments to the inside of the test equipment with the high voltage supply turned on. To avoid casualties, always remove power.

WARNING

Shock Hazard

Do not attempt to remove the RF transmission line while RF power is present.

WARNING

Do Not Service Or Adjust Alone

Under no circumstances should any person reach into an enclosure for the purpose of service or adjustment of equipment except in the presence of someone who is capable of rendering aid.

WARNING

Safety Earth Ground

An uninterruptible earth safety ground must be supplied from the main power source to test instruments. Grounding one conductor of a two conductor power cable is not sufficient protection. Serious injury or death can occur if this grounding is not properly supplied.

WARNING

Resuscitation

Personnel working with or near high voltages should be familiar with modern methods of resuscitation.

WARNING

Remove Power

Observe general safety precautions. Do not open the instrument with the power on.

Safety Symbols

WARNING

Warning notes call attention to a procedure, which if not correctly performed, could result in personal injury.

CAUTION

Caution notes call attention to a procedure, which if not correctly performed, could result in damage to the instrument.

Note: *Calls attention to supplemental information.*



The caution symbol appears on the equipment indicating there is important information in the instruction manual regarding that particular area.



This symbol appears on the equipment and indicates that the AC power cord should be removed before servicing the unit.



This symbol appears on the equipment and indicates the requirement for separate collection of discarded electrical and electronic equipment in accordance with the European Union Directive 2002/96/EC. Refer to the Bird web site for more information.

Warning Statements

The following safety warnings appear in the text where there is danger to operating and maintenance personnel, and are repeated here for emphasis.

WARNING

Leaking RF energy is a potential health hazard. Never attempt to connect or disconnect equipment from the transmission line while RF power is being applied. Severe burns, electrical shock, or death can occur.

See page 9.

WARNING

High RF voltage and energy is always present in the RF Test Port when the system is operating. Do not operate the system if the BPM-E RF Test Port is open. Close the port with a dummy plug or a suitable sampling plug. Failure to comply may result in severe burns, electrical shock, or death.

See page 10.

WARNING

Dangerous RF voltage. Do not connect or apply an RF signal to the BPM-E during equipment setup. Failure to comply may result in severe burns, loss of use of limbs, or death.

See pages 17, 19, and 20.

WARNING

Disconnect the unit from the RF power source and the ac line before any disassembly. The potential for electrical shock exists.

See page 38.

Caution Statements

The following equipment cautions appear in the text and are repeated here for emphasis.

CAUTION

BPM-E signal sensing couplers are fixed in place. Do not attempt to remove or rotate the couplers. They are calibrated and oriented at the factory and are not designed to be rotated or removed by the end user. Failure to comply may result in loss of calibration and accuracy, and in permanent damage to the unit.

See pages 10 and 24.

CAUTION

The DC voltage provided by the 3129 Digital Display power/alarm port should only be used to power the BPM-E. Do not use the 3129 DC source to supply power to anything else.

See page 13.

CAUTION

Network connections require specific address and protocol information. Have a qualified IT or network professional perform the BPME ethernet setup. Failure to comply may result in loss of network communication or the inability to communicate with the BPME.

See page 20.

CAUTION

Do not use harsh or abrasive detergents for cleaning.

See page 38.

Safety Statements

USAGE

ANY USE OF THIS INSTRUMENT IN A MANNER NOT SPECIFIED BY THE MANUFACTURER MAY IMPAIR THE INSTRUMENT'S SAFETY PROTECTION.

USO

EL USO DE ESTE INSTRUMENTO DE MANERA NO ESPECIFICADA POR EL FABRICANTE, PUEDE ANULAR LA PROTECCIÓN DE SEGURIDAD DEL INSTRUMENTO.

BENUTZUNG

WIRD DAS GERÄT AUF ANDERE WEISE VERWENDET ALS VOM HERSTELLER BESCHRIEBEN, KANN DIE GERÄTESICHERHEIT BEEINTRÄCHTIGT WERDEN.

UTILISATION

TOUTE UTILISATION DE CET INSTRUMENT QUI N'EST PAS EXPLICITEMENT PRÉVUE PAR LE FABRICANT PEUT ENDOMMAGER LE DISPOSITIF DE PROTECTION DE L'INSTRUMENT.

IMPIEGO

QUALORA QUESTO STRUMENTO VENISSE UTILIZZATO IN MODO DIVERSO DA COME SPECIFICATO DAL PRODUTTORE LA PROZIONE DI SICUREZZA POTREBBE VENIRNE COMPROMESSA.

SERVICE

SERVICING INSTRUCTIONS ARE FOR USE BY SERVICE - TRAINED PERSONNEL ONLY. TO AVOID DANGEROUS ELECTRIC SHOCK, DO NOT PERFORM ANY SERVICING UNLESS QUALIFIED TO DO SO.

SERVICIO

LAS INSTRUCCIONES DE SERVICIO SON PARA USO EXCLUSIVO DEL PERSONAL DE SERVICIO CAPACITADO. PARA EVITAR EL PELIGRO DE DESCARGAS ELÉCTRICAS, NO REALICE NINGÚN SERVICIO A MENOS QUE ESTÉ CAPACITADO PARA HACERLO.

WARTUNG

ANWEISUNGEN FÜR DIE WARTUNG DES GERÄTES GELTEN NUR FÜR GESCHULTES FACHPERSONAL.

ZUR VERMEIDUNG GEFÄHRLICHE, ELEKTRISCHE SCHOCKS, SIND WARTUNGSARBEITEN AUSSCHLIEßLICH VON QUALIFIZIERTEM SERVICEPERSONAL DURCHZUFÜHREN.

ENTRETIEN

L'EMPLOI DES INSTRUCTIONS D'ENTRETIEN DOIT ÊTRE RÉSERVÉ AU PERSONNEL FORMÉ AUX OPÉRATIONS D'ENTRETIEN. POUR PRÉVENIR UN CHOC ÉLECTRIQUE DANGEREUX, NE PAS EFFECTUER D'ENTRETIEN SI L'ON N'A PAS ÉTÉ QUALIFIÉ POUR CE FAIRE.

ASSISTENZA TECNICA

LE ISTRUZIONI RELATIVE ALL'ASSISTENZA SONO PREVISTE ESCLUSIVAMENTE PER IL PERSONALE OPPORTUNAMENTE ADDESTRATO. PER EVITARE PERICOLOSE SCOSSE ELETTRICHE NON EFFETTUARE ALCUNA RIPARAZIONE A MENO CHE QUALIFICATI A FARLA.

RF VOLTAGE MAY BE PRESENT IN RF ELEMENT SOCKET - KEEP ELEMENT IN SOCKET DURING OPERATION.

DE LA TENSION H.F. PEUT ÊTRE PRÉSENTE DANS LA PRISE DE L'ÉLÉMENT H.F. - CONSERVER L'ÉLÉMENT DANS LA PRISE LORS DE L'EMPLOI.

HF-SPANNUNG KANN IN DER HF-ELEMENT-BUCHSE ANSTEHEN - ELEMENT WÄHREND DES BETRIEBS EINGESTÖPSELT LASSEN.

PUEDA HABER VOLTAJE RF EN EL ENCHUFE DEL ELEMENTO RF - MANTENGA EL ELEMENTO EN EL ENCHUFE DURANTE LA OPERACION.

IL PORTAELEMENTO RF PUÒ PRESENTARE VOLTAGGIO RF - TENERE L'ELEMENTO NELLA PRESA DURANTE IL FUNZIONAMENTO.

About This Manual

This manual covers the operating and maintenance instructions for the following models:

3129

BPME

Figure 1 BPM-E Model Identification

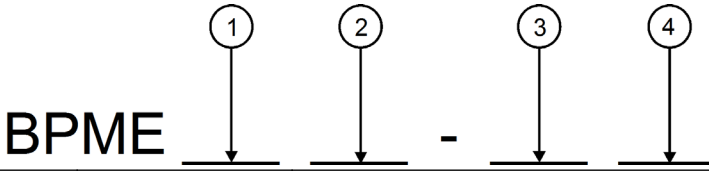

Item	Description	Options
1	Line Section	1 = 1 - 5/8" 3 = 3 - 1/8" 4 = 4 - 1/16" 4A = 4 - 1/2" 6 = 6 - 1/8"
2	Line Interface	U = Unflanged, Recessed Center Cond. UF = Unflanged, Flush Center Cond. D = Dielectric Flanged M = Myat Flanged leave blank = Flanged, EIA standard
3	Frequency Band	VL = 45 - 88 MHz V = 88 - 230 MHz U = 470 - 890 MHz
4	Power	L = Low M = Medium H = High X = Extra Low Refer to power ranges for each line section diameter ("RF Power Ratings" on page 45)

Figure 2 BPM-E7 Model Identification

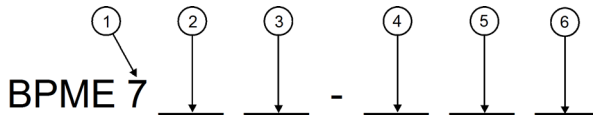

Item	Description	Options
1	Line Section	7 = 7/8"
2	Input Connector	A = N (F) B = N (M) C = LC (F) D = 7/8" EIA H = 7/16 DIN (F) J = 7/16 DIN (M) K = UHF (F) L = UHF (M)
3	Output Connector	A = N (F) B = N (M) C = LC (F) D = 7/8" EIA H = 7/16 DIN (F) J = 7/16 DIN (M) K = UHF (F) L = UHF (M)
4	Frequency Band	VL = 45 - 88 MHz V = 88 - 230 MHz U = 470 - 890 MHz
5	Power	L = Low M = Medium H = High refer to power ranges for each line section diameter (" RF Power Ratings " on page 45)
6	Mounting	P = Panel mount (for a 19 in. equipment rack) leave blank = Standard mounting configuration

Changes to this Manual

We have made every effort to ensure this manual is accurate. If you discover any errors, or if you have suggestions for improving this manual, please send your comments to our Solon, Ohio factory. This manual may be periodically updated. When inquiring about updates to this manual refer to the part number and revision on the title page.

Literature Contents

Chapter Layout

Introduction — Identifies the parts and functions of the BPM-E and the 3129 Display Panel, and lists optional equipment available.

Theory of Operation — Describes the theory and features of the BPM-E and the Display, including the alarm options.

Installation — Provides information on installing the BPM-E and 3129 Digital Display at a site, as well as information on the cable connections and installation instructions for the WebTool utility and the PCTool software.

Operating Instructions — Describes operation of the display and use of the PCTool software and the WebTool software.

Maintenance — Lists basic troubleshooting information, routine maintenance tasks for the BPM-E and the 3129 digital display, specifications, and parts lists.

TABLE OF CONTENTS

Safety Precautions	i
Safety Symbols	ii
Warning Statements	iii
Caution Statements	iv
Safety Statements	v
About This Manual	viii
Changes to this Manual	x
Literature Contents	x
Chapter Layout	x
Chapter 1 Introduction	1
Broadcast Power Monitor	1
Features	1
Items Supplied	1
Optional Items Available	2
Digital Display	2
Features	2
Component Description	3
Chapter 2 Theory of Operation	6
General Theory	6
Factors that Affect Power Reading Accuracy	6
Alarm Response	7
Alarm Reset	7
Alarm Latching	7
VSWR Alarm	7
Alarm on Zero Power	8
High Power Alarm	8
Low Power Alarm	8
Chapter 3 Installation	9
Unpacking and Inspection	9
Tools Required	9
Mounting a BPM-E	9
BPM-E7	10
Flanged Connector	11
Unflanged Connector	11
3129 Digital Display	12
Mounting a 3129 Digital Display	12
AC Power Connector	12
Alarm Interlocks	12
Remote Computer Connector	13

Power/Alarm Connector	13
Power ON/OFF Switch	13
BPM-E DC Power Connections	13
Setting Up the BPM-E	17
Installing PCTool and Finder	17
Connecting the BPM-E Using the RS-232 Port	18
Connecting the BPM-E Using the Ethernet Port	20
Chapter 4 Operating Instructions	24
Couplers	24
BPM-E Controls	24
3129 Digital Display	24
Power On	24
Mode Button	25
Units Button	25
Reset Button	25
Alarm LED	25
WebTool Software	25
Main Screen	26
Stats Screen	27
Config Screen	28
Alarm Tab	28
Frequency Tab	29
Admin Screen	30
Network Tab	30
Email Alerts Tab	30
SNMP Tab	31
Password Tab	32
Help Screen	32
PCTool Software	33
Connection	34
View	34
Main	34
Config	35
Frequency Tab	37
Chapter 5 Maintenance	38
Inspection and Cleaning	38
3129 Digital Display Fuses	38
Specifications	39
BPM-E Specifications	39
3129 Digital Display Specifications	41
RF Power Range, VHF Frequency Band (45-230 MHz)	42
Troubleshooting	44
Replacement Parts	44

RF Power Ratings	45
Line Section Sizes	46
3129 Digital Display	48
Customer Service	49
Appendix 1 Reference Information	50
Determining VSWR Alarm Trip Point	50
Limited Warranty	51

This chapter contains introductory information including items supplied and component descriptions.

Broadcast Power Monitor

The Enhanced Bird Broadcast Power Monitor (BPM-E) is a compact, microprocessor controlled instrument intended for long-term system VSWR and power monitoring. The BPM-E is designed for use only with shielded (grounded) 50 ohm transmission lines. See [Figure 31 on page 46](#) for an outline drawing with dimensions.

Features

- Compatible with analog or digital systems
- Monitors VSWR and power
- Measures forward power from 2.5 W to 200 kW, measurable reflected power from 0.25 W to 20 kW (actual measurement ranges depend upon frequency and line diameter size)
- Remote monitoring capability
- Multiple alarm options
- May be used at any point in the transmission line
- Available in a variety of line sections
- Can send an e-mail when an alarm occurs
- Supports ethernet connection
- Provides an extra socket for connecting an RF test element

Items Supplied

- Broadcast Power Monitor
- Instruction Manual
- PCTool software (on CD)

Optional Items Available

3129 Digital Display — Displays the BPM-E status and provides power to the BMPE electronics. Includes a power cord, a 50 foot 9-pin cable, and a 50 foot 15-pin cable.

DB-15 Power/Alarm Cable — Connects the BPM-E to a power supply and to external controllers. 50 feet long with male/female connectors. Refer to [Figure 7 on page 14](#) for pin layout.

DB-15 Interface Connector — Allows easy custom data cable connections to the BPM-E.

DB-9 RS-232 PC Interface Cable — Connects the BPM-E to a PC. Available in either 10 or 50 foot lengths, with male/female connectors. Refer to [Figure 10 on page 16](#) for pin layout.

Digital Display

The Bird 3129 Digital Display is a remote monitor panel that can be used with the BPM-E.

Features

- A single line display divided into two fields.
Note: *Displays forward power, and either reflected power or the match measurement. An indicator in the lower right of the last digit blinks on and off to indicate communication with the BPM-E.*
- Displays match measurements as VSWR, Rho, Return Loss, or efficiency
- Supplies DC power to the BPM-E
- Displays the BPM-E alarm status
- Provides an electrical interface for the discrete outputs from the BPM-E
- Provides a serial interface to connect a PC to the BPM-E

Component Description

Figure 1 BPM-E Components

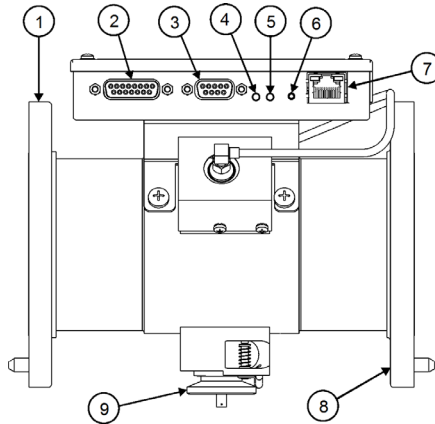

Item (Fig. 1)	Function	Description
1	RF Input	Input to BPM-E from transmitter
2	Power/Alarm Parallel Port	Connects to the 3129 digital display using a 15 pin cable. Note: Also used for remote operation.
3	RS-232 Serial Port	Connects to a 3129 digital display, a PC, or other display panel using a 9 pin RS-232 cable
4	Alarm LED	Red LED, lights when an alarm is triggered
5	Monitor On LED	Green LED, lights when the unit is powered
6	Reset Switch	Press to reset the alarm. If an alarm trigger is still present, the alarm will reactivate
7	Ethernet Port	Connects to a network or PC ethernet card
8	RF Output	Output from BPM-E to antenna or load
9	RF Test Port	Insert a sampling element with an appropriate connector to connect to a monitor device (e.g. spectrum analyzer, modulation monitor, oscilloscope)

Figure 2 3129 Digital Display Components

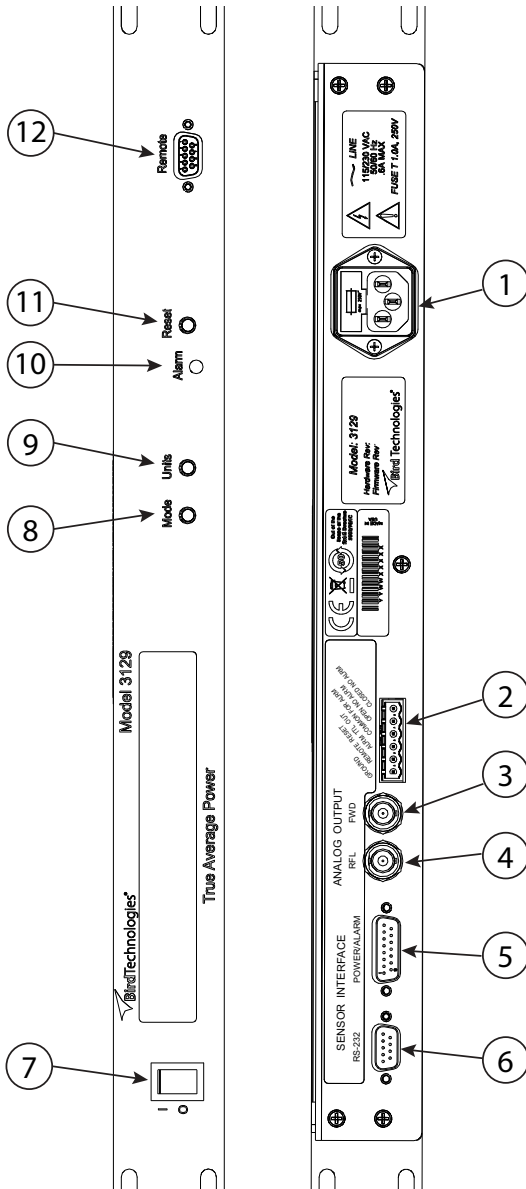

Item (Fig. 2)	Function	Description
1	AC Power Connector	Connect to ac power supply with a power cord
2	Alarm Interlocks	Alarm interlocks are used to shut down transmitter when an alarm condition occurs. Remote reset can be used to reset the BPM-E after the alarm event
3	Analog Output, Forward Power	0 to 2 V full scale, linear, 200 ohm output impedance, BNC (f) connector
4	Analog Output, Reflected Power	0 to 2 V full scale, linear, 200 ohm output impedance, BNC (f) connector
5	Power/ Alarm Port	Connects to the BPM-E using a 15 pin cable. Provides operating power to the BPM-E. Contains analog and digital alarm information.
6	RS-232 Serial Port	Connects to the BPM-E using a 9 pin RS-232 cable (ASCII data between the BPM-E and the display)
7	AC Power Switch	Turns on the display panel (and BPM-E if connected).
8	Mode Button	Selects display mode for the right field.
9	Units Button	Selects the displayed power units.
10	Alarm LED	Red LED, lights when an alarm is triggered
11	Reset Switch	Press to reset the alarm. If an alarm trigger is still present, the alarm will reactivate
12	Remote Computer Connector	Interface with a PC using a 9 pin RS-232 cable

General Theory

The enhanced Broadcast Power Monitor (BPM-E) is an instrument that is inserted directly into a transmission line to monitor the forward power, reflected power, and VSWR of the system. The BPM-E consists of a line section with forward and reflected directional couplers and an additional housing that contains the external circuitry. The external circuitry consists of a detector circuit and a control circuit ([Figure 3 on page 6](#)).

The directional couplers sample, through a known coupling factor, the forward and reflected wave in the transmission line. The coupled RF signal is passed to the detector board and converted into a DC voltage. The DC voltage, which is proportional to the RF power in the line section, is then sent to the control circuit.

In the control circuit, an analog-to-digital converter digitizes the incoming signal and passes it to a micro controller that manages input and output processing. The control circuitry communicates by sending signals to the alarm and power LEDs, receiving a user initiated signal from the reset button, and both sending and receiving signals via the RS-232 connector (DB9), the Ethernet connector (RJ45), and the power/alarm connector (DB15).

Factors that Affect Power Reading Accuracy

Many sources can affect the accuracy of any in-line power reading. These sources include directivity of the directional couplers, noise in the system, and the insertion loss of various system components. To more fully understand how these and other sources cause the power readings to be out of specification, consult with a Bird Applications Engineer.

Figure 3 BPM-E Functional Block Diagram

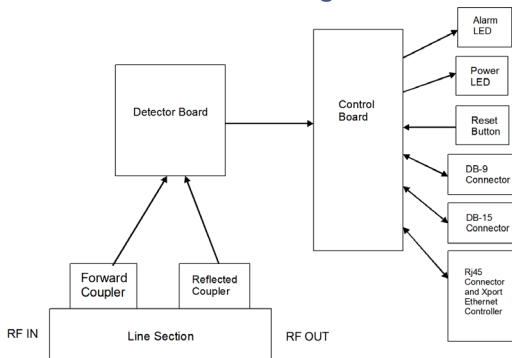

Alarm Response

When an alarm is triggered, the Bird Broadcast Power Monitor turns on the alarm LEDs, provides a TTL alarm out signal (low = alarm), and deactivates a form-C dry contact relay. Additionally the BPM-E can latch the alarm condition and notify up to two persons via email if you have set up this option in the WebTool software.

Note: *The alarm relay defaults to fail safe. That is, the relay is de-energized when an alarm activates or when power is lost. If you need to have an alarm relay that energizes on an alarm, contact Bird (see title page of this manual).*

Alarm Reset

After an alarm occurs, you can reset it in the following ways:

- Press the reset switch on the BPM-E or on the digital display.
- Apply a TTL logic low signal (0 to 0.8 VDC) to the reset pin on the Power/Alarm connector.
- Use the PCTool software to reset the unit through the RS-232 port.
- Use the WebTool software to reset the unit through the Ethernet port.

Alarm Latching

The alarm defaults to latching operation. In this mode, the alarm will stay active until reset. In non-latching mode, the alarm will reset automatically about forty seconds after the trigger condition is corrected. The latching mode can be changed using the PCTool or the WebTool.

VSWR Alarm

Activating the VSWR also enables all other alarms that have been selected. Conversely, deactivating the VSWR alarm disables all other alarms that have been selected.

The BPM-E continuously monitors forward and reflected power. From the power measurements, the VSWR is calculated and compared to the allowed maximum (default of 1.8 to 1). Based on the results of the comparison, possible actions include:

- No alarms are activated if the VSWR is less than the maximum, or if the VSWR alarm is disabled.

- If:
- The VSWR is equal to or slightly greater than the maximum, additional measurements are accumulated to determine a trend.
- Reverse power is increasing, an alarm is triggered.
- The reverse power is stable, measurements continue until a trend is established.
An alarm will be set if the VSWR exceeds the maximum for more than thirty seconds.
- If the VSWR is much greater than the maximum then an alarm is triggered immediately.

Alarm on Zero Power

When the forward power is very small (< 2.5% of full scale), the measured VSWR becomes large due to the noise floor of the sensor. Under these conditions, the VSWR level is meaningless. When the zero power alarm is disabled, the VSWR will not be monitored at these low powers.

High Power Alarm

When the high power alarm is enabled, the forward power is continuously monitored. The alarm trigger is a percentage of the Monitor's full scale power, from 0 – 125%. If the forward power is greater than the trigger level, an alarm is triggered.

Low Power Alarm

When the low power alarm is enabled, the forward power is continuously monitored. The alarm trigger is a percentage of the Monitor's full scale power, from 0 – 125%. If the forward power is less than the trigger level, an alarm is triggered.

This chapter provides information for preparing the Bird Broadcast Power Monitor for use.

Unpacking and Inspection

1. Carefully inspect the shipping container for signs of damage. If damage is noticed, do not unpack the unit. Immediately notify the shipping carrier and Bird Electronic Corporation.
2. If the shipping container is not damaged, unpack the unit. Save the packing material in case the unit needs to be shipped again.
3. Inspect all of the components for visible signs of damage. Immediately notify the shipping carrier and Bird Electronic Corporation of equipment damage or missing parts.

The Bird BPM-E is shipped complete and ready for use upon receipt. After unpacking and inspecting the unit, it is ready to be installed.

Tools Required

You will need only common hand tools to install the BPM-E and the 3129 Digital Display (if used).

WARNING

Leaking RF energy is a potential health hazard. Never attempt to connect or disconnect equipment from the transmission line while RF power is being applied. Severe burns, electrical shock, or death can occur.

Mounting a BPM-E

Make sure that the LEDs and reset button are accessible, and that the connecting cables have adequate clearance. Mount the BPM-E in the transmission line between the transmitter and the antenna. "In" or "RF Input" is the signal *from your transmitter*. "RF Output" is the signal going *to the antenna or load*. Follow the instructions in this section to mount a BPM-E7 (See "[BPM-E7" on page 10](#)), a BPM-E with a flanged connector (See "[Flanged Connector" on page 11](#)"), or a BPM-E with an unflanged connector (See "[Unflanged Connector" on page 11](#)"). Be sure to connect the BPM-E to the RF line as described.

WARNING

High RF voltage and energy is always present in the RF Test Port when the system is operating. Do not operate the system if the BPM-E RF Test Port is open. Close the port with a dummy plug or a suitable sampling plug. Failure to comply may result in severe burns, electrical shock, or death.

CAUTION

BPM-E signal sensing couplers are fixed in place. Do not attempt to remove or rotate the couplers. They are calibrated and oriented at the factory and are not designed to be rotated or removed by the end user. Failure to comply may result in loss of calibration and accuracy, and in permanent damage to the unit.

BPM-E7

The BPM-E uses QC-type quick change connectors. Use 50 ohm coaxial cable such as RG-218/U or RG-220/U (-17A or -19A), appropriate for the frequency and power level of operation. Use a cable connector that will mate with both the transmission line and the BPM-E7. Connect the BPM-E7 to the RF line as shown in [Figure 4 on page 10](#).

Figure 4 *BPM-E 7, RF Direction*

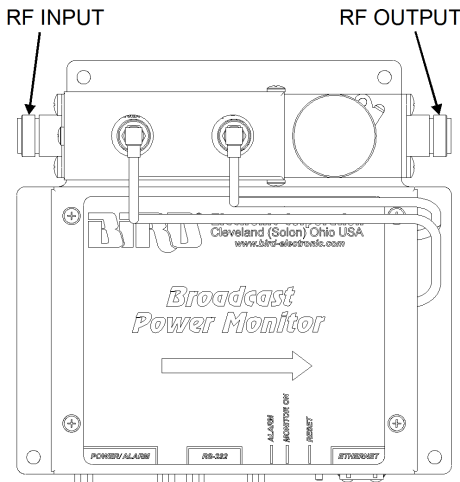

Flanged Connector

To connect a flanged unit to a flanged RF transmission line, use an appropriate coupling kit. Refer to [Figure 5 on page 11](#) for RF input and output orientation.

1. Insert the center connector (bullet).

Note: *Push the connector until it is fully seated.*

2. Connect the coaxial input in a straight line.

Note: *Push carefully to close.*

3. Insert the bolt sets.
4. Tighten the bolt sets evenly all around to transmission line manufacturer's recommended torque.

Note: *Use all of the bolts.*

Unflanged Connector

To connect an unflanged unit to an unflanged RF line, use an appropriate coupling kit.

1. Insert the center connector (bullet).

Note: 1. Push the connector until it is fully seated.

2. Position the outer sleeve, with clamping bands, over the input connector.
3. Set the transmission line snugly against the coupling stops.
4. Position the clamping bands evenly about 3/4" from the ends of the sleeve.
5. Tighten the clamping bands.

Figure 5 *BPM-E Flanged Line Sections, RF Direction*

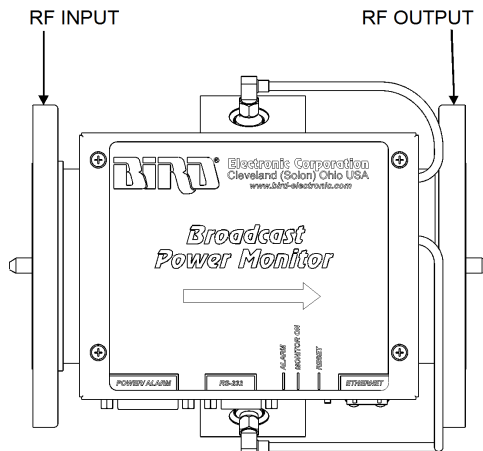

3129 Digital Display

Note: When using with a BPME, it is recommended to connect the 3129 directly to a universal power source (UPS).

Mounting a 3129 Digital Display

Install the digital display in a standard (1U) rack mount.

AC Power Connector

The AC Power connector ([Figure 2 on page 4](#)) provides operating power for the digital display and the BPM-E electronics. The AC power supply cord is also the line disconnect device for this product. You can use any approved power cord to connect to the digital display, such as domestic type SVT, 300 VAC, 18 AWG, 10 A, 3 conductor (including ground) or international type H05VV-F, 300 VAC, 1.00 mm, 10 A, 3 conductor (including ground).

Alarm Interlocks

When an alarm occurs, the 3129 Digital Display utilizes one of the following two methods to shut down your system.

- A TTL signal (Alarm TTL Out) that goes low on alarm
- A relay (alarm relay) that de-energizes on alarm

The alarm interlocks are available at the alarm interlock connector at the rear of the unit ([Figure 6 on page 12](#)).

Note: The alarm relay label text has been revised for clarity. If you are connecting to an older Bird 3129 display, the alarm interlock connector might have the “old label” text.

Figure 6 Alarm Interlock Connections

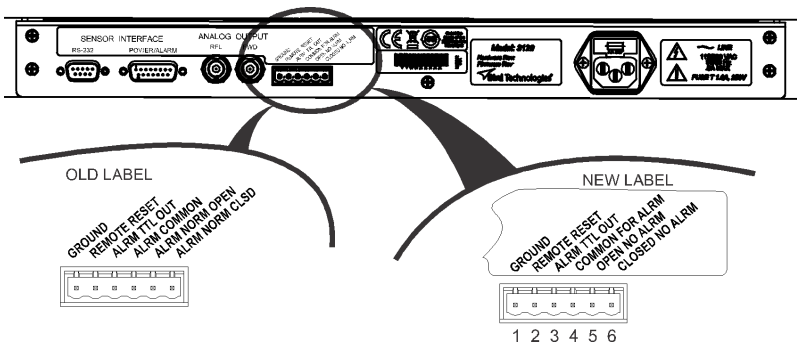

Pin # (Fig. 6)	New Label Text and Description
1	Ground
2	Remote Reset (reset TTL alarm signal, TTL low = reset)
3	Alarm TTL Out (low = alarm)
4	Common for Alarm (relay contact common)
5	Open No Alarm (relay energized, contacts are open when no alarm exists)
6	Closed No Alarm (relay energized, contacts are closed when no alarm exists)

Remote Computer Connector

To communicate with a BPM-E that is connected to the RS-232 port at the rear of the 3129 Digital Display, connect a PC to the Remote Computer connector on the front panel of the display. When connected in this manner, signals are routed directly from the BPM-E through the display to the PC.

To setup a BPM-E connected to the Remote Computer connector (as described above), follow the setup instructions for RS-232 and PC Tool software in ["Setting Up the BPM-E" on page 17](#).

Power/Alarm Connector

The Power/Alarm connector provides operating power to the BPM-E and receives signals and data from the BPM-E. Pin numbers and descriptions are given in [Figure 7 on page 14](#) and a typical connection is illustrated in [Figure 8 on page 15](#).

CAUTION

The DC voltage provided by the 3129 Digital Display power/alarm port should only be used to power the BPM-E. Do not use the 3129 DC source to supply power to anything else.

Power ON/OFF Switch

The power switch on the front of the display turns the unit ON or OFF.

BPM-E DC Power Connections

Connect DC operating power to the BPM-E Power/Alarm 15-pin connector.

The BPM-E requires an isolated +12 to +26 VDC power supply (0.5 A max). This power is available from the Power/Alarms connector at the rear of the 3129 Digital Display.

If your installation does not use a 3129 Digital Display, you must provide the required power and connect it to the BPM-E Power/Alarm 15-pin connector. The BPM-E Power/Alarm connector also provides alarm signals (TTL and relay contacts), a reset line, and forward and reflected power information. See [Figure 7 on page 14](#) for the connector pin descriptions.

Figure 7 DB-15 Power/Alarm Connector

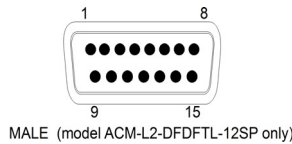

Pin	Description
1	Relay, normally closed contact (closed when relay is not energized) (open when there is no alarm)
2	Relay, common contact
3	Alarm output, TTL compatible TTL High (≥ 4.3 VDC with a 10k load) = no alarm TTL Low (<0.2 VDC) = alarm
4	Forward monitor, 0 to 2 VDC linearly proportional to forward power, 200 ohm output impedance
5	Reset input, TTL compatible TTL Low (<0.5 VDC) resets alarm
6-7	No connection
8	Reflected monitor, 0 to 2 VDC linearly proportional to reflected power, 200 ohm output impedance
9	Relay, normally open contact (open when relay is not energized) (closed when there is no alarm)
10-11	Reserved
12-13	DC input, +12 to +26 VDC (<0.5 A)
14-15	Ground for DC input and signals

BPM-E Data Connections

The BPM-E has an RS-232 connector and an Ethernet connector. The RS-232 connector conducts ASCII data between the BPM-E and a display panel or a PC. The Ethernet connector conducts data between the BPM-E and a network device (hub, router, PC with network capability). [Figure 8 on page 15](#) shows how a BPM-E can be connected to a Bird 3129 Digital Display. RS-232 pin numbers and descriptions are given in [Figure 10 on page 16](#). When you connect using the RS-233 port, you will use the PCTool software utility to communicate with the BPM-E.

If you connect the BPM-E to the rear panel of a 3129 Digital Display (RS-232 connection), you can also connect a PC to the RS-232 connector on the front of the display (Remote connector) to communicate with the BPM-E.

The Ethernet connector provides a means for you to connect the BPM-E to a network or directly to a computer with Ethernet capability that is not connected to a network. When you use the Ethernet capability, you will also use the WebTool utility to set the IP address, configure the BPM-E, and monitor the power and alarm status of the transmission line.

Figure 8 *BPM-E Rear Panel Data Connections*

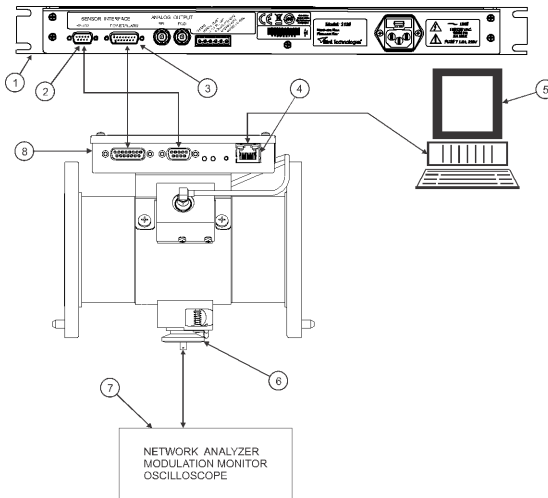

Item	Description
1	3129 Digital Display, rear panel
2	RS-232 communication port, 9-pin
3	Power/Alarm connector, 15-pin
4	Ethernet connector (for network or local PC)
5	Computer (for network or local PC)

Item	Description
6	Sampler port
7	Monitor device (network analyzer, modulation monitor, oscilloscope)
8	BPM-E controller

Figure 9 BPM-E Front Panel Data Connections

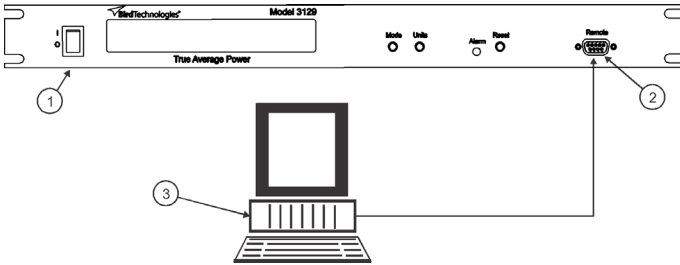

Item	Description
1	3129 Digital Display, front panel
2	3129 Remote computer connector
3	Computer (PC)

Figure 10 DB-9 RS-232 Connector

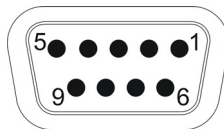

Pin	Description
1	Carrier Detect, always > +5 C
2	Transmit Output, RS-232 data signal
3	Receive Input, RS-232 data signal
4	Data Set Ready Input, connected but not used
5	Data Signal Ground
6	Data Terminal Ready Output, connected but not used
7	Clear-To-Send, shorted internally to Ready-To-Send
8	Ready-To-Send, shorted internally to Clear-To-Send
9	Ring Indicator, no connection

Setting Up the BPM-E

Note: *It is recommended to connect the BPME directly to a universal power source (UPS).*

If you connect directly to a display instead of a computer or network, you can begin using the BPM-E, as shipped, with the factory default alarm and frequency settings. However, you should change the settings (frequency, alarms, etc.) to fit your application. To make changes to any of the settings or to set up the BPM-E to communicate with a computer, you need to use either the PCTool (used with RS-232 connection) or the WebTool and the Finder utility (used with Ethernet connection).

Note: *To use the PCTool software or the WebTool software, your PC must have the Java runtime environment (Java virtual machine v1.4.2 or later) installed prior to connecting the BPM-E. If you do not have the runtime environment, you can find it on the CD that came with your BPM-E or you can download it from the web at www.java.com or from the Bird Technologies web site (www.birdrf.com). For information about downloading the Java Runtime Environment, refer to the readme.txt file that was provided on the CD shipped with your unit.*

Installing PCTool and Finder

WARNING

Dangerous RF voltage. Do not connect or apply an RF signal to the BPM-E during equipment setup. Failure to comply may result in severe burns, loss of use of limbs, or death.

1. Make sure that there is **NO** RF power applied to the BPM-E.
2. Copy the file named SETUP.EXE from the CD that came with your unit to a temporary folder on your hard drive. You can also download SETUP.EXE from the Bird Technologies web site (www.birdrf.com).
3. Launch SETUP.EXE from your hard drive. Typically if you double-click the file name, the file will launch.
4. Follow the on-screen instructions to complete the installation. When the installation is complete, you will see the PCTool main screen with no data in the fields ([Figure 11 on page 18](#)).

Note: *IF you have an older version of PCTool installed on your computer, the installation process in this step will uninstall the older version. To install the newer version, you must run SETUP.EXE a second time.*

Figure 11 PCTool Installation Screen

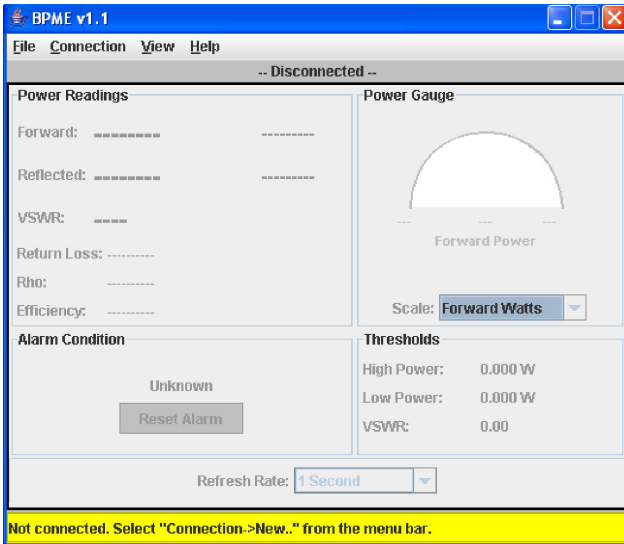

5. Do one of the following to set up your BPM-E:
 - If you connect your BPM-E directly to a display panel (such as the Bird 2139 Digital Display) using an RS-232 cable, or you connect it directly to a PC using an RS-232 cable, follow the setup instructions described in "[Connecting the BPM-E Using the RS-232 Port](#)" on page 18.
 - If you connect your BPM-E directly to a PC or to a network using an Ethernet cable, follow the setup instructions described in "[Connecting the BPM-E Using the Ethernet Port](#)" on page 20.

Connecting the BPM-E Using the RS-232 Port

The RS-232 communication protocol is fixed in the firmware and cannot be modified.

1. Connect the computer's serial port, via a DB-9 cable, directly to the BPM-E or to the BPM-E through a 3129 digital display.

Note: Do not use a null modem adapter.

2. Install the Java runtime environment, refer to "[Setting Up the BPM-E](#)" on page 17.

Note: Perform this step if it is not already done.

WARNING

Dangerous RF voltage. Do not connect or apply an RF signal to the BPM-E during equipment setup. Failure to comply may result in severe burns, loss of use of limbs, or death.

WARNING

Do not connect RF power to the unit.

3. Apply operating power to the BPM-E. Refer to "[BPM-E Data Connections](#)" on page 15).
4. Launch PCTool from your hard drive.
5. Specify which COM (serial) port the BPM-E will use:
 - a. On the Menu bar, click on Connection and select New...
 - b. On the New Connection dialog box, select the computer COM port to which the BPM-E is connected then click OK ([Figure 12](#) on page 19).

Note: When the BPM-E establishes communication with your PC, the PCTool software will display the COM port being used in the space immediately below the Menu bar.

Note: To use the features of the PCTool software, refer to "[Operating Instructions](#)" on page 24.

Figure 12 PCTool, Select a COM Port

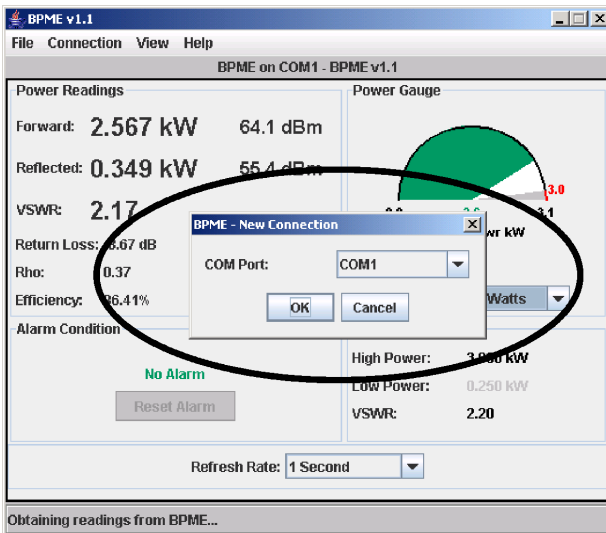

Connecting the BPM-E Using the Ethernet Port

When you connect to the BPM-E using the Ethernet port, you use the WebTool software to setup the BPM-E. You do not need to install the WebTool software because it is part of the BPM-E firmware.

Note: *You must have Java runtime installed before you can use the WebTool software.*

CAUTION

Network connections require specific address and protocol information. Have a qualified IT or network professional perform the BPM-E Ethernet setup. Failure to comply may result in loss of network communication or the inability to communicate with the BPM-E.

The setup in this section should be performed only by a person who thoroughly understands IP and network setup protocols.

Note: *If you are connecting to a network, before you begin, do the following:*

- Contact your IT professional to get the subnet mask values for your network and to determine whether or not your network has a DHCP server.
 - Inform your network administrator that the BPM-E will use port 10001. The network administrator might need to open this port before you can set up the BPM-E.
1. Install the Java runtime environment (refer to ["Setting Up the BPM-E" on page 17](#)).

Note: *Perform this step if it is not already done.*

Note: *To use the WebTool software, your PC must have the Java runtime environment (Java virtual machine v1.4.2 or later) installed prior to connecting the BPM-E to an Ethernet device. If you do not have the runtime environment, you can download it from the web at www.java.com or from the Bird Technologies web site (www.birdrf.com). For information about downloading the Java 2 Runtime Environment, refer to the readme.txt file that was provided with your unit.*

WARNING

Dangerous RF voltage. Do not connect or apply an RF signal to the BPM-E during equipment setup. Failure to comply may result in severe burns, loss of use of limbs, or death.

WARNING

Do not connect RF power to the unit.

- Apply operating power to the BPM-E, refer to "[BPM-E Data Connections](#)" on page 15).
- Follow the Ethernet setup flowchart ([Figure 13 on page 21](#)) to complete the installation.

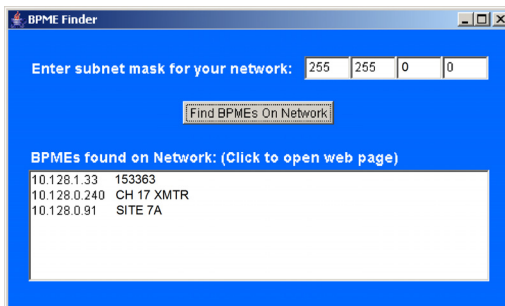
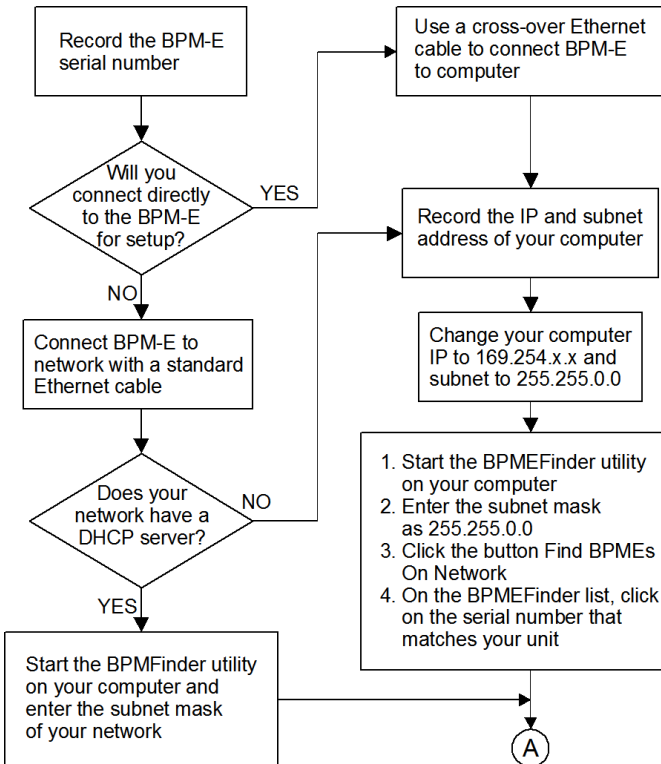
Figure 13 Ethernet Connection Flowchart

A

When you click on the serial number that matches your unit, the WebTool starts. If WebTool doesn't start, your web browser is not in your path. Either add it to your path or open your Web browser and enter the IP address of the BPM-E in the address bar. `http://<ip address>`

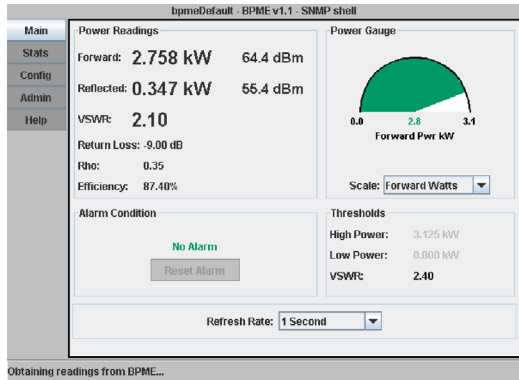

B

D

Click on 'Email Alerts' tab and check the 'Enabled' box.

Fill out 'Email From' field to set the BPM-E's name on the network (or leave it as is to identify the BPM-E it by serial number).

Uncheck the 'Enabled' box to disable email alerts.

OR

Leave the 'Enabled' box checked and fill out the 'Email Recipient' fields and SMTP server IP address.

E

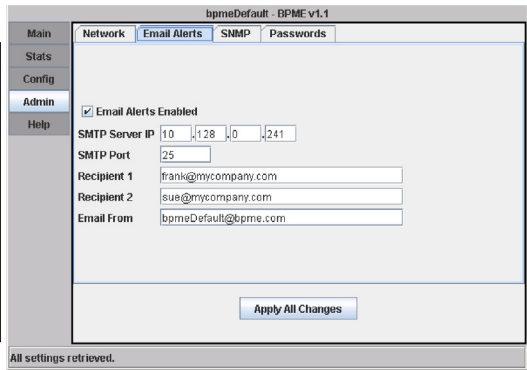

Note: The name you enter (at the left of the @ symbol) is also used in the BPM-E Finder utility. If you use the email option to notify someone that an alarm has occurred, the name of this BPM-E will help identify where the alarm came from.

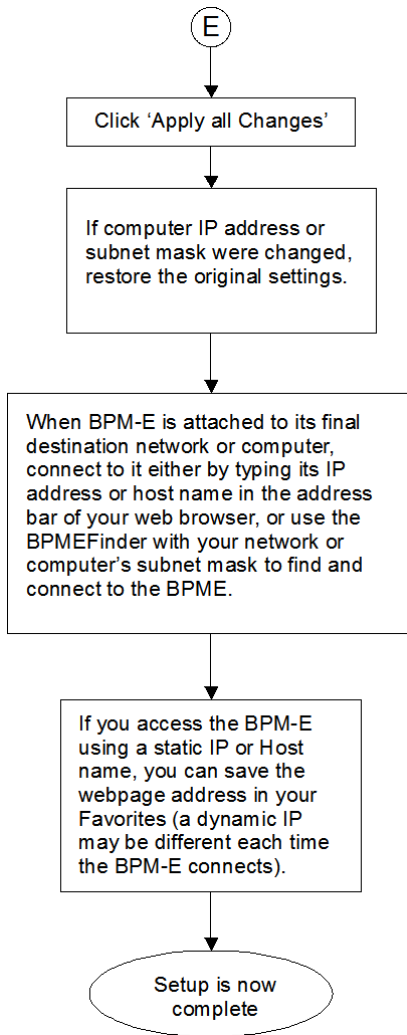

Note: To use the features of the WebTool software, refer to ["Operating Instructions" on page 24.](#)

This chapter provides a description of controls and indicators on the BPM-E and the 3129 Digital Display. Read and become familiar with the following instructions before operating the unit.

Couplers

The BPM-E does not use elements to sense the RF signal. It uses couplers. The couplers are fixed in place.

CAUTION

BPM-E signal sensing couplers are fixed in place. Do not attempt to remove or rotate the couplers. They are calibrated and oriented at the factory and are not designed to be rotated or removed by the end user. Failure to comply may result in loss of calibration and accuracy, and in permanent damage to the unit.

BPM-E Controls

There are two indicators and one control on the BPM-E:

Monitor On LED (green) — Lights when the unit is powered.

Alarm LED (red) — Lights when an alarm has been triggered.

Reset Switch — Press to reset an alarm. If the alarm trigger condition is still present, the alarm will reactivate.

3129 Digital Display

Power On

After the AC power switch is set to ON, a message will be displayed. Examples of possible messages are:

- 'Digital display ver x.xxx' Shown at power-up for about 4 seconds.
- 'Waiting...!' Shown when no response is received from the BPM-E.
- 'Serial Pass Thru...' Shown when a PC or other remote device is connected to the Remote Computer Connector on the front panel.

Mode Button

Press MODE to cycle through the possible display modes for the right half of the display, which are:

- Reflected Power
- Match Efficiency (%)
- Return Loss (dB)
- VSWR (SWR)
- Reflection Coefficient (ρ)

Units Button

Press UNITS to toggle the display between Watts (W or kW) and dBm. The unit applies to forward power and to reflected power (if it is displayed).

Reset Button

Resets the alarm LED if the alarm condition is no longer present. Directly connected to the Reset Input pin of the BPM-E Power/Alarm connector.

Alarm LED

Indicates the presence of an alarm condition. Directly connected to the Alarm pin on the BPM-E Power/Alarm connector.

WebTool Software

The BPM-E WebTool software is used to monitor the measurement outputs from the BPM-E and to set and change alarm and network configurations. This software runs in a web browser (such as Microsoft's Internet Explorer). To use the tool, open a web browser then in the address field, type the address of the BPM-E you wish to access. The software has five buttons at the left side that open the following screens: Main, Stats, Config, Admin, and Help. You can access information about the WebTool software by click on the Help button.

Main Screen

The Main screen is the default screen you see when you open the WebTool software (Figure 14 on page 26). The Main screen identifies the BPM-E at the top of the window. The center of the screen displays measurement data that is being received from the BPM-E. You can set the refresh rate from 1 second to 60 seconds (how frequently the software updates the data from the BPM-E). At the bottom of the window, the status bar displays various information about the software and uses three alert colors, red - a fatal error (cannot establish connection, connection lost), yellow - a warning (cannot complete a user request, user does not have access permission), gray - normal operation.

For more information about the Main screen features, refer to the help section in the software (click on the Help button).

The alarm condition area (Figure 15 on page 27) will display three conditions

- No alarm (green text) - no alarm condition exists
- Latched (red text) - an alarm condition did occur but its cause has been fixed or the cause no longer exists.
- Alarm (red text) - an alarm condition that has occurred and has not gone away or been reset is identified by text (VSWR, High Pwr, Low Pwr, or any combination of these if more than one alarm exists).

You can reset the alarm at the BPM-E by pressing the reset button or by clicking on the Reset Alarm button on the Web Tool Main screen. If the cause of the alarm is still present, the message cannot be reset.

Figure 14 *BPM-E WebTool Software, Main Screen*

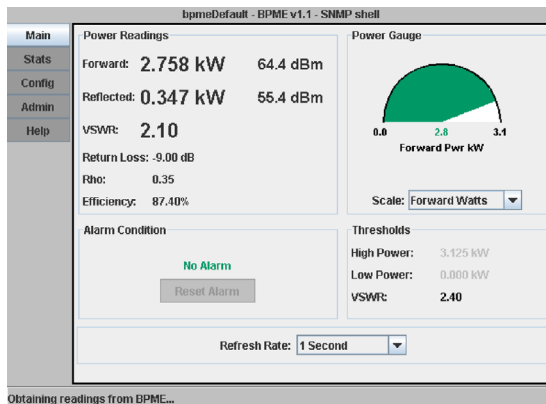
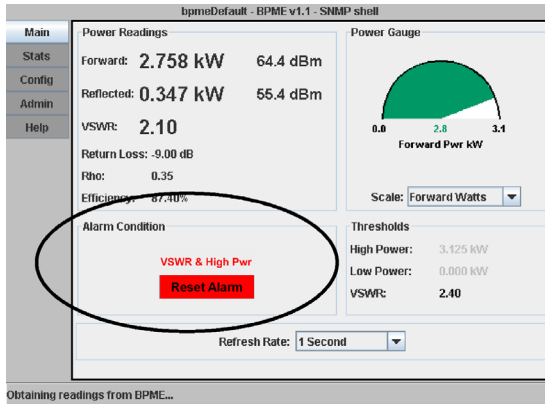

Figure 15 Alarm Active Message



Stats Screen

The Stats screen (Figure 16 on page 27) can chart and display historical data stored in the BPM-E memory. You can chart forward and reflected power readings and alarm conditions (low power, high power, and VSWR alarm). You can display the data in either a line graph or a bar chart.

The BPM-E keeps data for a 365 day period. You select the starting day (in the Begin field) and the number of days to view. Day 0 is today, day 1 is yesterday, and so on to day 364. Click the Add >> button to add the days to the list to view.

When you click the Chart It button, the WebTool retrieves the data and generates a new chart. Click the Clear button to clear your day selection.

For more information about the Stats screen features, refer to the help section in the software (click on the Help button).

Figure 16 Web Tool Stats Screen

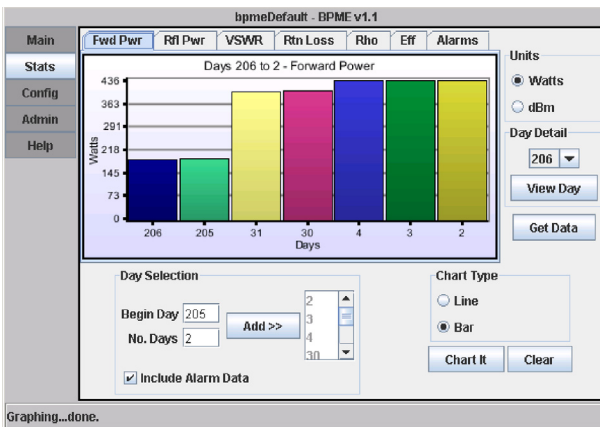

Config Screen

The Config (Configure) screen has two tab views, Alarms and Frequency. The administrator of the WebTool can set an optional password requirement to control who can make changes to the Config screen (refer to Admin Screen for password control).

For more information about the Config screen, refer to the help section in the software (click on the Help button).

Alarm Tab

In the Alarms tab ([Figure 17 on page 29](#)), you specify BPM-E alarm settings. To return to the factory default alarm settings, click on the Factory Default button. After you have set the alarm preferences, click the Apply Changes button to record your settings in memory.

You can select or deselect the following alarm conditions:

Master Alarm Enable — When checked, activates the VSWR alarm and enables all other alarm conditions that have been selected (boxes checked), disables all alarms when not checked.

VSWR trip point — Specify the VSWR value that will cause an alarm (select values from the drop-down list). This value is adjustable from 1.3 to 2.5 by increments of 0.1. Check the VSWR Alarm Enabled on Zero Power checkbox to allow the VSWR alarm to trigger at very low forward power (< 2.5% of full scale power). Refer to "[Determining VSWR Alarm Trip Point](#)" on [page 50](#) for additional information about limitations of the VSWR trip point.

High Power Alarm (forward power only) — Check the Enable box and specify the percentage of full scale at which an alarm will occur. The high power value must be greater than the low power value. The maximum value is 125% of full scale power. The alarm setpoint is entered as a percent of full scale. For example, if you have a 500W full scale unit and would like an alarm when the forward power exceeds 375 W, the alarm setpoint would be $375/500 \times 100$ or 75%. Enter 75 in the field and check the Enable High Power Alarm checkbox.

Low Power Alarm (forward power only) — Check the Enable box and specify the percentage of full scale at which an alarm will occur. The low power value must be less than the high power value. The minimum is 0%.

Latch Alarms — Sets whether the alarm will reset automatically in the absence of an alarm condition. When this checkbox is unchecked, if an alarm trigger is corrected, the alarm will reset after a forty-five second delay. When the box is checked, the alarm must be manually reset.

Trigger Alarm Button — After you have set or made changes to alarm settings, you can use the Trigger Alarm button to test the alarms (messages, relay, TTL outputs). If the Config password is enabled, you will be required to enter the password before you can test the alarm settings.

Figure 17 WebTool Config Screen, Alarms

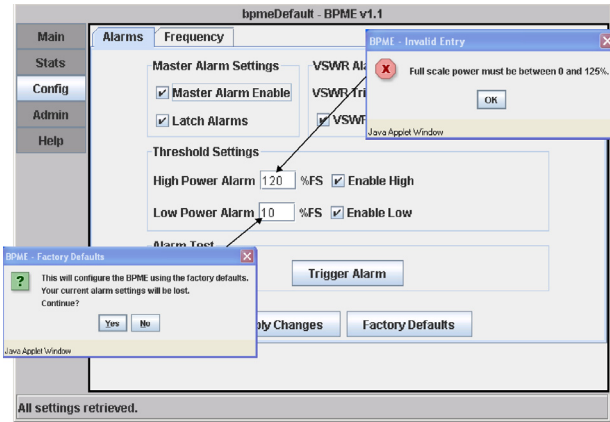

Frequency Tab

In the Frequency view (Figure 18 on page 29), you specify monitor frequencies and then apply that configuration to the BPM-E. Click the View Channel List button to display a list of United States television channels and their frequencies (Figure 18 on page 29). To add a frequency to the Selected Frequencies list, type it in the Frequency (MHz) field, then click the Add button. To remove a frequency from the list, click on the frequency to select it, then click on the Remove button. After you have set the configuration frequencies, click the Configure button to record your settings to memory. The value shown beside Configuration Frequency is the center frequency of all of the values in the Selected Frequencies list.

Note: *The changed frequencies stored in memory will not take effect until the BPM-E power has been turned off and then back on.*

Figure 18 Web Tool Config Screen, Frequency

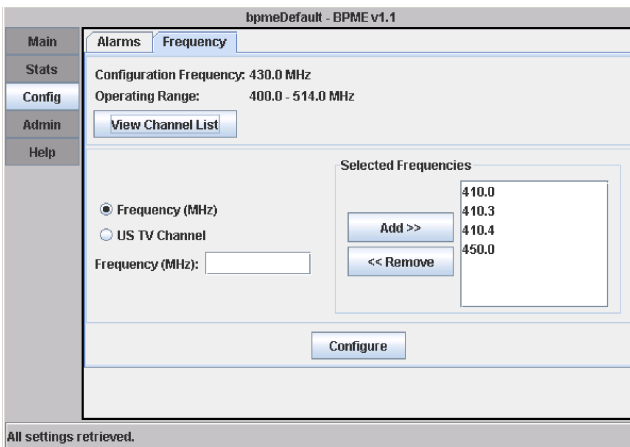

Admin Screen

The Admin screen has four tabs, Network, Email Alerts, SNMP, and Passwords. After making changes in one or all of the tabs, click the Apply All Changes button to record your settings in memory.

For more information about the Admin screen, refer to the help in the software (click on the Help button).

Network Tab

In the Networking tab (Figure 19 on page 30), you can specify the following information about the address of the BPM-E: IP address, subnet mask, gateway IP, DHCP host name, and whether or not DHCP is used.

If you use the Ethernet connection to communicate with the BPM-E, you need to specify a unique IP address. An IP address is required even if you connect the BPM-E directly to a computer that is not on a network. Contact your IT professional for assistance in determining the IP address, subnet mask, and information about DHCP use and name.

Figure 19 WebTool Admin Screen, Network Setup

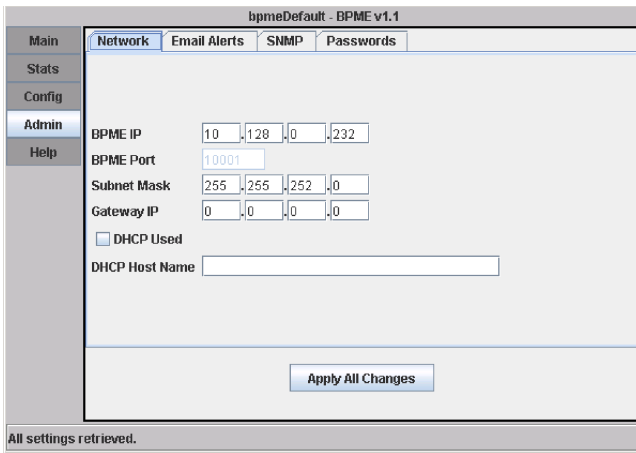

Email Alerts Tab

In the Email Alerts tab (Figure 20 on page 31), you can specify the following information: the SMTP server IP, the SMTP port, whether or not to use the email alerts, the email address of the BPM-E, and the email addresses of two people to notify when an alarm occurs (optional).

You can have the WebTool software contact two specified recipients via email if an alarm occurs. The BPM-E needs to be connected to a computer or server that has email capabilities. Contact your IT professional for assistance in determining the SMTP server IP and port. The text you enter at the left of the @ symbol in the From email address will uniquely identify this BPM-E in all sent emails. Use text that will identify the BPM-E and its location. The text at the right of the @ symbol is the email domain information for your server.

Figure 20 WebTool Admin Screen, Email Alerts

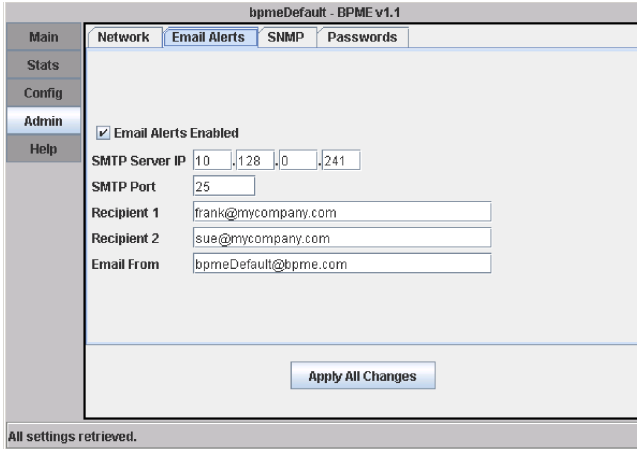

SNMP Tab

In the SNMP tab ([Figure 21 on page 31](#)), you can specify setup for the SNMP feature if you have chosen to use it. Contact your IT professional for assistance. You can obtain the latest MIB file from the Bird Technologies web site.

Figure 21 WebTool Admin Screen, Set SNMP Email Address

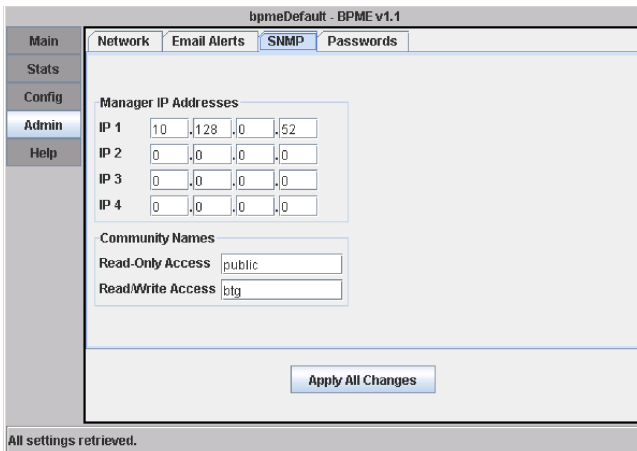

Password Tab

In the Password tab ([Figure 22 on page 32](#)), you can set the administrator password and the optional configuration access password. When you set or change a password, you must type the password a second time in the appropriate “confirm” field before it will be accepted.

You must have a password to view and edit the Admin screen. The default password is “bird” (lower case without the quotes). After you make changes, click on the Apply All button.

If a configuration access password is set, users can view the Config screen but not edit it. A password must have at least 3 and no more than 49 characters.

Figure 22 Web Tool Admin Screen, Passwords

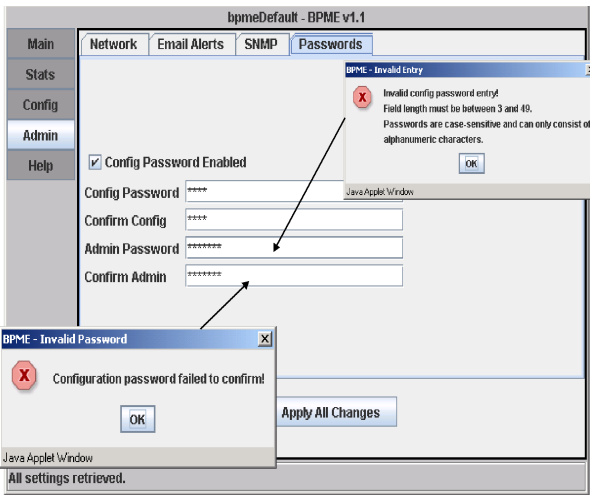

Help Screen

While you are using the WebTool software, you can get help about the screens and features by clicking on the Help button at the left side of the screen.

PCTool Software

The BPM-E PCTool software is used to monitor the measurement outputs from the BPM-E and to set and change alarm configurations. This software is a stand-alone application that must be installed onto your PC. To use the tool, launch it from the computer's operating system menus or from a shortcut on your desktop.

Note: *Your PC must have the Java runtime environment (java virtual machine) installed to run the PCTool software. For Windows operating systems, this is typically installed by default. If you do not have the runtime environment, you can download it from the java.com web site (look for Java Software for Desktop).*

The PCTool screen ([Figure 23 on page 33](#)) is divided into three parts, the Menu bar at the top, the information area in the center, and the status bar at the bottom. The BPM-E identification and the COM port being used appear in the space immediately below the Menu bar. The status bar displays various information about the software and uses three alert colors, red - a fatal error (cannot establish connection, connection lost), yellow - a warning (cannot complete a user request), gray - normal operation. The Menu bar has the following four entries:

File — Contains the command to exit the software

Connection — Contains two options, New (select a COM port), and Close (disconnect the BPM-E from the PC)

View — Contains two options, Main (open the Main screen) and Config (open the Config and Alarm screen)

Help — Provides information about the software version and opens the on-line help screens.

Figure 23 PCTool Screen, Main Screen

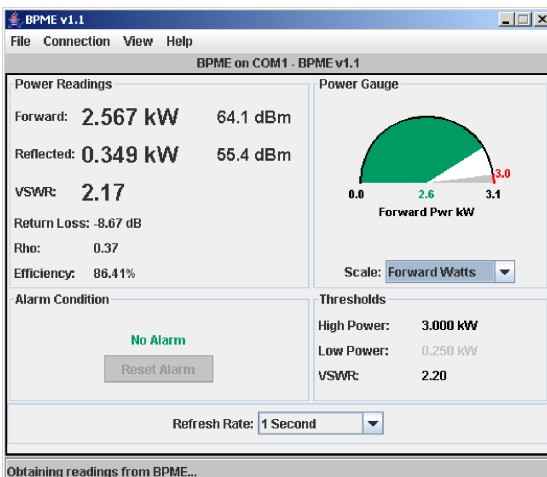

Connection

The PCTool software must be set to use the correct computer COM port to communicate with the BPM-E. The default port is COM 1. To change the Com port, select Connection from the Menu bar, then select New. Choose the COM port you want from the drop-down list in the dialog box then click OK ([Figure 24 on page 34](#)).

Note: *The Connection menu also has a Close command. Choosing the Close command will close (break) the COM port connection to the computer.*

For more information about the Connection screen features, refer to the help section in the software (click on Help on the Menu bar).

Figure 24 *PCTool Software, New Connection Com Menu*

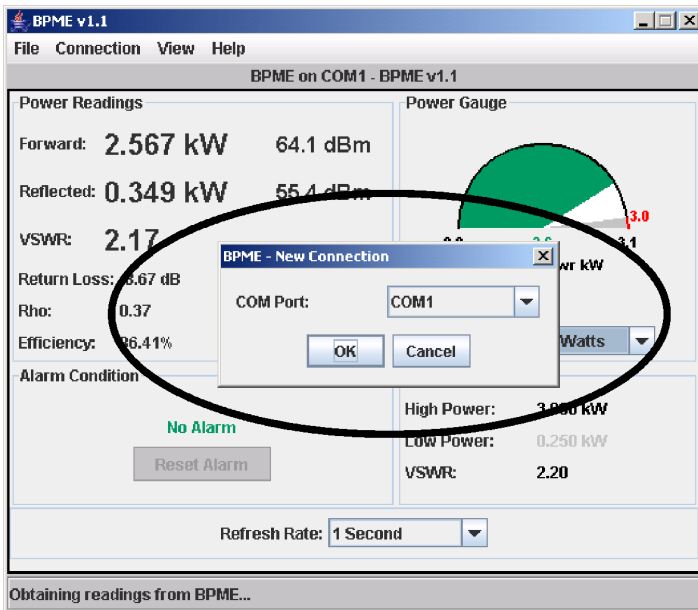

View

The View menu has two options, Main and Config.

Main

The "Main" screen ([Figure 23 on page 33](#)) is the default screen you see when you open the PCTool software. It displays forward and reflected power, VSWR, return loss, Rho, efficiency, and alarm conditions.

The alarm condition area displays information in three colors:

No alarm (green text) — No alarm condition exists

Latched (red text) — An alarm has happened, but has cleared

Alarm (red text) — An alarm has happened and is identified (VSWR, High Pwr, Low Pwr, or any combination of these if more than one alarm exists)

If an alarm has occurred and has not been reset, the alarm text will be red and will display which alarm (or alarms) occurred ([Figure 25 on page 35](#)). You can reset the alarm at the BPM-E or by clicking on the Reset Alarm button on the Main screen. If the alarm condition is still present, the message cannot be reset.

You can also set the refresh rate from 1 second to 60 seconds (how frequently the software updates the data from the BPM-E).

For more information about the Main screen features, refer to the help section in the software (click on Help on the Menu bar).

Figure 25 PCTool Main Screen (alarm display)

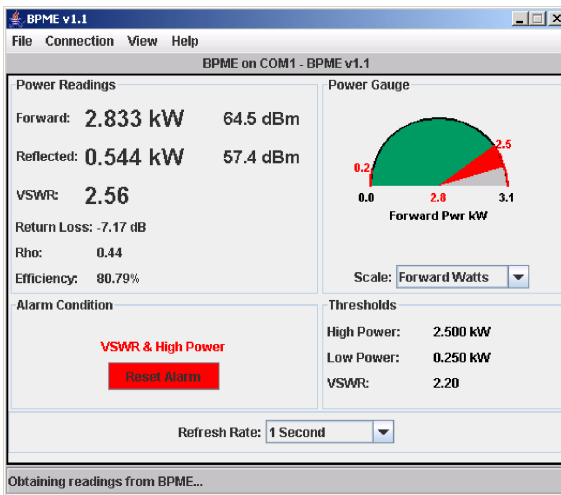

Config

The Configure (Config) screen has two tab views, Alarms and Frequency.

Alarm Tab — In the Alarms tab ([Figure 26 on page 36](#)), you specify BPM-E alarm settings. To return to the factory default alarm settings, click on the Factory Default button. After you have set the alarm preferences, click the Apply Changes button to record your settings in memory.

Figure 26 Config Screen, Alarm Tab

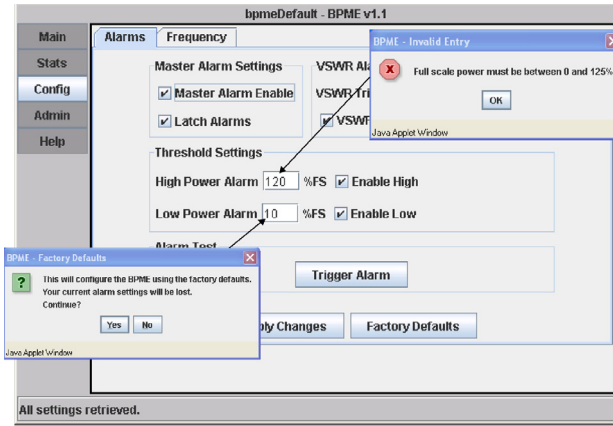

You can select or deselect the following alarm conditions:

Master Alarm Enable — When checked, activates the VSWR alarm and enables all other alarm conditions that have been selected (boxes checked), disables all alarms when not checked.

VSWR trip point — Specify the VSWR value that will cause an alarm (select values from the drop-down list). This value is adjustable from 1.3 to 2.5 by increments of 0.1. Check the VSWR Alarm Enabled on Zero Power checkbox to allow the VSWR alarm to trigger at very low forward power (< 2.5% of full scale power).

High Power Alarm (forward power only) — Check the Enable box and specify the percentage of full scale at which an alarm will trigger. The high power value must be greater than the low power value. The maximum value is 125% of full scale power. The alarm setpoint is entered as a percent of full scale. For example, if you have a 500W full scale unit and would like an alarm when the forward power exceeds 375 W, the alarm setpoint would be 375/500 x 100 or 75%. Enter 75 in the field and check the Enable High Power Alarm checkbox.

Low Power Alarm (forward power only) — Check the Enable box and specify the percentage of full scale at which an alarm will trigger. The low power value must be less than the high power value. The minimum is 0%.

Latch Alarms — Sets whether the alarm will reset automatically in the absence of an alarm condition. When this checkbox is unchecked, if an alarm trigger is corrected, the alarm will reset after a forty-five second delay. When the box is checked, the alarm must be manually reset.

After you have set or made changes to alarm settings, you can test the settings by clicking on the Trigger Alarm button.

Frequency Tab

In the Frequency tab (Figure 27 on page 37), you specify monitor frequencies and then apply that configuration to the BPM-E. Click the View Channel List button to display a list of United States television channels and their frequencies (Figure 28 on page 37). To add a frequency to the Selected Frequencies list, type it in the Frequency (MHz) field, then click the Add button. To remove a frequency from the list, click on the frequency to select it, then click on the Remove button. After you have set the configuration frequencies, click the Configure button to record your settings to memory. The value shown beside Configuration Frequency is the center frequency of all of the values in the Selected Frequencies list.

Figure 27 Config Screen, Frequency Tab

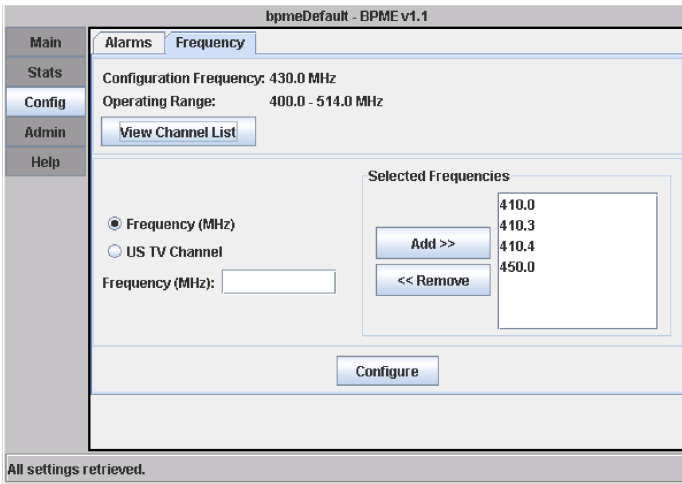

Figure 28 US Television Channel List

Channel	Center Freq	Range
2	57	54 - 60 MHz
3	63	60 - 66 MHz
4	69	66 - 72 MHz
5	79	76 - 82 MHz
6	85	82 - 88 MHz
7	177	174 - 180 MHz
8	183	180 - 186 MHz
9	189	186 - 192 MHz
10	195	192 - 198 MHz
11	201	198 - 204 MHz

This chapter contains cleaning, troubleshooting, specifications, and part information for the Bird Broadcast Power Monitor and the 3129 Digital Display.

Inspection and Cleaning

This unit requires only simple and routine maintenance.

WARNING

Disconnect the unit from the RF power source and the ac line before any disassembly. The potential for electrical shock exists.

CAUTION

Do not use harsh or abrasive detergents for cleaning.

1. Wipe off dust and dirt regularly. Use a soft, clean cloth dampened with mild detergent.
2. Check connectors, connector pins, and cables for damage. If needed, clean the connectors using a self-drying contact cleaner that leaves no residue.

3129 Digital Display Fuses

The 3129 Digital Display contains two time-delayed IEC (5 x 20mm) Type T 1.0A, 250V fuses. These are the only user replaceable parts. Refer to figure [Figure 29 on page 39](#) for fuse location.

Figure 29 3129 Digital Display, Fuse Location

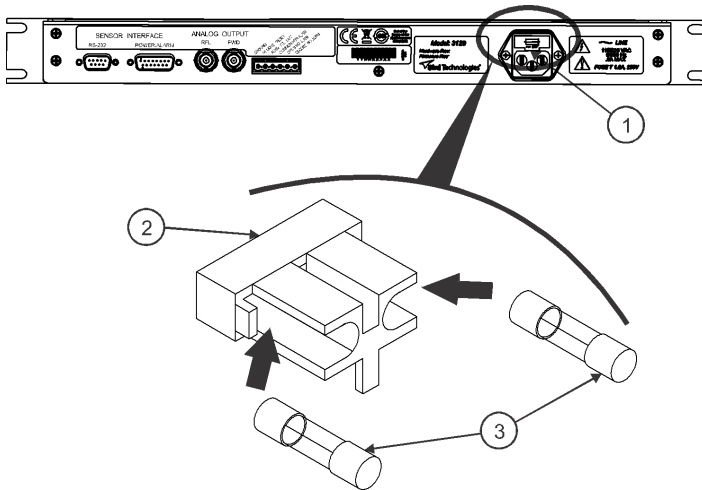

Item	Description
1	Fuse holder tab, pry outward to remove fuse holder
2	Fuse holder
3	Fuse

Specifications

BPM-E Specifications

Frequency Range	
VHF low	45 – 88 MHz
VHF	88 - 230 MHz
UHF	470-890 MHz
Dynamic Range, Min	20 dB
Max Allowable Peak/Average Ratio	10 dB min. at max RF power
Insertion Loss, Max	0.05 dB
Directivity, Min	26 dB min, 30 dB typical
Detection Method	True Average Power
Impedance	50 ohms

<p>Accuracy Power</p> <p>Calibrated for FM band TV Channels 1-6</p> <p>TV Channels 7-83</p> <p>VSWR Display Resolution RMS Noise</p>	<p>NOTE: Refer to "Factors that Affect Power Reading Accuracy" on page 6 in the Theory of Operation to learn about factors that can cause power readings to be out of spec.</p> <p>± 5% of reading</p> <p>± 5% of reading at calibrated channel ± 1 channel</p> <p>± 5% of reading at calibrated channel ± 4 channels</p> <p>Calculated from Fwd and Rfl power</p> <p>± 1 digit</p> <p>0.1 % of full scale</p>
<p>Connectors, RF</p>	<p>See "Line Section Sizes" on page 46</p>
<p>RS-232 Serial Port Connector Protocol</p> <p>DC Power Required Analog Outputs</p>	<p>Female DB-9</p> <p>9600 baud, no parity, 8 data bits, 1 stop bit, no handshake</p> <p>+12 to +26 Vdc @ <0.5A</p> <p>2V full scale, 0 to 2V range, 200 ohm output impedance, linear scale.</p>
<p>Ethernet port Network Interface Compatibility Protocols</p> <p>Left LED Right LED Security Power/Alarm Parallel Port Display Options</p>	<p>Ethernet 10/100 BASE-T (auto sensing)</p> <p>Ethernet version 2.0 / IEEE 802.3</p> <p>ARP, UDP/IP, TCP/IP, DHCP, BOOTP, AutoIP, and HTTP</p> <p>Amber: 10 Mbps. Green: 100 Mbps</p> <p>Amber: Half-duplex. Green: Full-duplex</p> <p>128 bit encryption</p> <p>Female DB-15 connector</p> <p>BPM-E-PCTool, 3129 digital display, Site Analyzer, BPM-E-WebTool</p>

Alarm	
Alarm Relay	Dry, contacts, with common, normally open, and normally closed connections (form C)
Relay Contact Rating	100 Vdc @ 0.5 A
VSWR set points	1.3 to 2.5:1 by 0.1 steps, measurement limited by max input power
Alarm Stimulus	VSWR, high forward power, low forward power
Alarm Response	Turn on red LED; trip relay; set software flag; set alarm line low (<0.2V); Send email Response time is inversely proportional to the overload
Alarm Reset	Push button on BPM-E Push button on 3129 digital display Ethernet or RS-232 command TTL low (Vdc=0 to +0.8 V)
Alarm Power Up	Alarm defaults to fail-safe (alarm on when unit is not powered)
Environmental	
Operating Temp	0 to +50 °C (+32 to 122 °F)
Storage Temp	-20 to +80 °C (-4 to +176 °F)
Humidity	95% max. (non-condensing)
Altitude	3000 m (10,000 ft.) above sea level
CE	CE compliant
Calibration Cycle	> 1 year
Recommended Calibration Cycle Interval	User defined
Dimensions	See " Line Section Sizes " on page 46
Weight, Nominal	See Figure 31 on page 46

3129 Digital Display Specifications

Display	20 character LCD with LED backlight
RS-232 Serial Port	
Connector	Male DB-9
Protocol	RS-232, 9600 baud, no parity, 8 data bits, 1 stop bit, no handshake
Power/Alarm Parallel Port	Male DB-15 connector
Remote Computer Connector	
Connector	Female DB-9
Protocol	RS-232, 9600 baud, no parity, 8 data bits, 1 stop bit, no handshake
AC Power Requirements	115/230 Vac @ 50/60 Hz, 0.6 A

AC Connector Domestic	North American Power Cord Standard Type SVT, 300 VAC, 18 AWG, 10 A, 3 conductor (including ground)
International	Type H05VV-F, 300 VAC, 1.00 mm, 10 A, 3 conductor (including ground)
Temperature Operating	-10 to +50 °C (+14 to 122 °F)
Storage	-40 to +80 °C (-40 to +176 °F)
Humidity	95% max. (non-condensing)
Altitude	3000 m (10,000 ft.)
Dimensions	19" L x 1.75" W x 5" H (483 x 44 x 127 mm) (1U EIA)
Weight, Nominal	< 10 lbs

RF Power Range, VHF Frequency Band (45-230 MHz)

Line size	Unit power range	Measurable Range, Fwd	Measurable Range, Rfl
7/8"	High Med Low	5000 - 50 W 2000 - 20 W 500 - 5 W	500 - 5 W 200 - 2 W 50 - 0.5 W
1-5/8"	High Med Low	20 - 0.2 kW 8000 - 80 W 2000 - 20 W	2000 - 20 W 800 - 8 W 200 - 2 W
3-1/8"	High Med Low Extra Low	50 - 0.5kW 20 - 0.2 kW 5000 - 50 W 1000 - 10 W	5000 - 50 W 2000 - 20 W 500 - 5 W 100 - 1 W
4-1/16" and 4-1/2"	High Med Low	100 - 1 kW 40 - 0.4 kW 10 - 0.1 kW	10 - 0.1 kW 4000 - 40 W 1000 - 10 W
6-1/8"	High Med Low	200 - 2 kW 80 - 0.8 kW 20 - 0.2 kW	20 - 0.2 kW 8000 - 80 W 2000 - 20 W

RF Power Range, UHF Frequency Band (470-890 MHz)

Line size	Unit power range	Measurable Range, Fwd	Measurable Range, Rfl
7/8"	High Med Low	2500 - 25 W 1000 - 10 W 250 - 2.5 W	250 - 2.5 W 100 - 1 W 25 - 0.25 W
1-5/8"	High Med Low	5000 - 50 kW 2000 - 20 W 500 - 5 W	500 - 5 W 200 - 2 W 50 - .05 W
3-1/8"	High Med Low Extra Low	25 - 0.25 kW 10 - 0.1 kW 2500 - 25 W 1000 - 10 W	2500 - 25 W 1000 - 10 W 250 - 2.5 W 100 - 1 W
4-1/16" and 4-1/2"	High Med Low	40 - 0.4 kW 15 - 0.15 kW 4000 - 40 W	4000 - 40 W 1500 - 15 W 4000 - 4 W
6-1/8"	High Med Low	75 - 0.75 kW 30 - 0.3 kW 8000 - 80 W	7500 - 75 W 3000 - 30 W 800 - 8 W

Troubleshooting

The Bird Broadcast Power Monitor has no operator serviceable parts. Any required service must be performed at an authorized service facility.

The table below contains troubleshooting information for problems which can occur during normal operation. This manual cannot list all malfunctions that may occur or their corrective actions. If a problem is not listed or is not corrected by the listed actions, notify a qualified service center.

PROBLEM	POSSIBLE CAUSE	CORRECTION
Monitor On LED does not illuminate	No DC power	Check power source, and 15 pin power/alarm cable
	Defective LED	Return the unit to an authorized service center
Alarm LED does not illuminate when alarm exists	Defective LED	Return the unit to an authorized service center
	Defective power/alarm cable	Repair or replace cable
High VSWR	Dirty connectors	Clean connectors
	Defective connectors	Replace connectors
	Shorted or open transmission line	Have the line serviced.
Digital display screen does not light	Unit is not turned on	Set AC Power Switch to ON
	Unit is not plugged in	Connect AC power cord
	Fuse is blown	Replace fuse

Replacement Parts

Description	Part Number
Digital Display	3129
9 pin RS-232 Interface Cable 50 ft. 10 ft.	5A2264-09-MF-50 5A2264-09-MF-10
DB-15 Interface Cable, 50 ft., male/female	5A2264-15-MF-50
DB-15 Interface Connector	SUBCON-15/M-SH
Fuse, for 3129 digital display (1 amp, slow blow)	5A2257-16

RF Power Ratings

For power ratings based upon line sizes, refer to "[Specifications](#)" on page 39.

Note: For a specific frequency and line size, the maximum safe operating power may be lower than the full scale power measurement capability of the BPME.

Line Section Max RF Power vs. Frequency

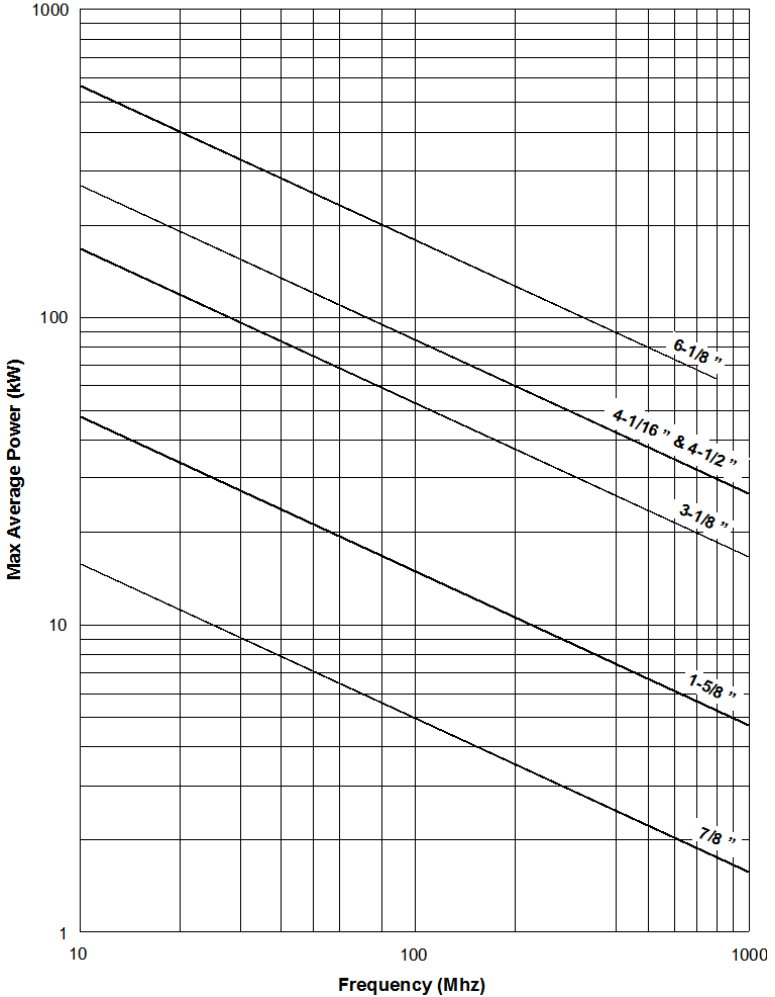

Line Section Sizes

Figure 30 BMPE Dimensions, Model BPM-E7

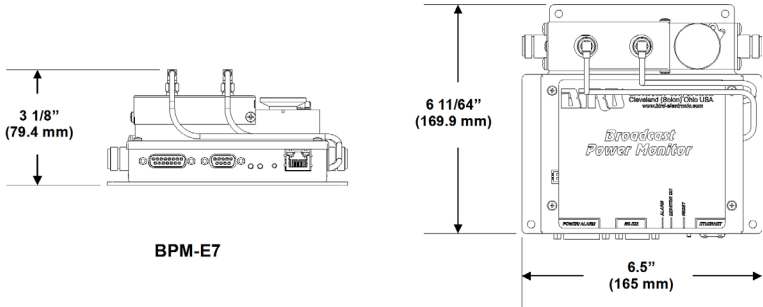
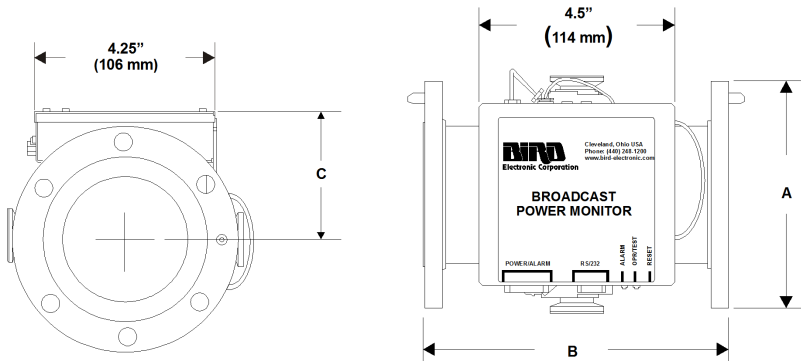

Figure 31 BPM-E Dimensions, Flanged and Unflanged Models



Model	Connector	Dim. A ¹	Dim. B	Dim. C	Inner Conductor Setback	Weight
BPME1	1-5/8" EIA Flanged	3.50" (89 mm)	6.75" (171.5 mm)	2.98" (75.7 mm)	EIA	3.25 lbs. (1.5 kg)
BPME1U	1-5/8" EIA Unflanged	1-5/8" (41.3 mm)	6.38" (162 mm)	2.98" (75.6 mm)	0.438" (11.1 mm)	1.5 lbs. (0.68 kg)
BPME1UF	1-5/8" EIA Unflanged, Flush Center	1-5/8" (41.28 mm)	6.38" (162 mm)	2.98" (75.6 mm)	0	1.5 lbs. (0.68 kg)
BPME3	3-1/8" EIA Flanged	5.19" (132 mm)	7.03" (178.6 mm)	3.4" (86.4 mm)	EIA	7.25 lbs. (3.3 kg)
BPME3U	3-1/8" EIA Unflanged	3-1/8" (79.4 mm)	6.5" (165.1 mm)	3.4" (86.4 mm)	0.688" (17.5 mm)	4.25 lbs. (1.93 kg)
BPME3UF	3-1/8" EIA Unflanged, Flush Center	3-1/8" (79.4 mm)	6.5" (165.1 mm)	3.4" (86.4 mm)	0	4.25 lbs. (1.93 kg)
BPME4AUF	4-1/2" IEC Unflanged	4.17" (106 mm)	7.5" (190.5 mm)	3.96" (100.7 mm)	0.06" (1.5 mm)	10 lbs. (4.55 kg)
BPME4D	4-1/16" Flanged, Dielectric Standard	6.19" (157 mm)	8.38" (212.8 mm)	3.87" (98.2 mm)	1.22" (31 mm)	8.88 lbs. (4 kg)
BPME4M	4-1/16" Flanged, Myat Standard	6.19" (157 mm)	8.38" (212.8 mm)	3.87" (98.2 mm)	1.375" (35 mm)	8.88 lbs. (4 kg)
BPME6	6-1/8" EIA Flanged	8.13" (206 mm)	10.22" (259.6 mm)	4.96" (126 mm)	EIA	17 lbs. (4 kg)
BPME6U	6-1/8" EIA Unflanged	6-1/8" (155.6 mm)	9.63" (244.6 mm)	4.96" (126 mm)	0.968" (24.6 mm)	12.75 lbs. (5.78 kg)
BPME7	7/8" line, Type N connectors	1.25" (318 mm)	n/a	n/a	n/a	1.25 lbs. (0.57 kg)

¹ For unflanged units, this dimension is the outer diameter of the transmission line.

3129 Digital Display

Figure 32 3129 Digital Display Dimensions

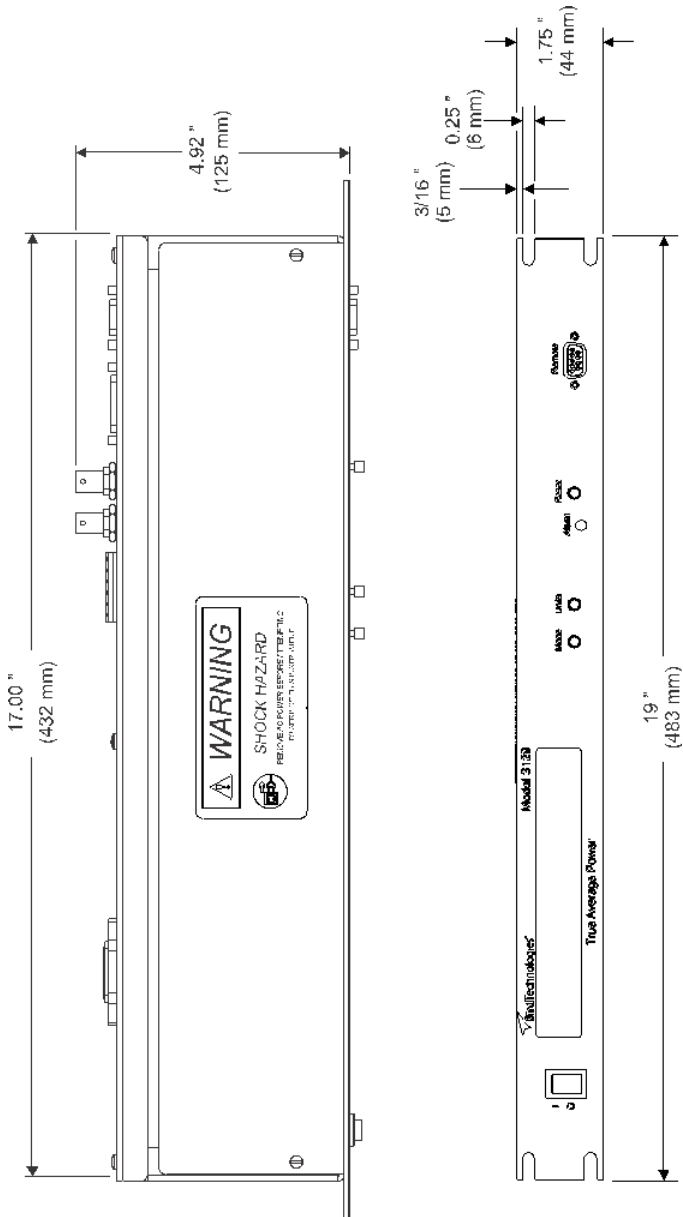

Customer Service

Any maintenance or service procedure beyond the scope of those in this chapter should be referred to a qualified service center.

If the unit needs to be returned for any reason, request an Return Material Authorization (RMA) through the Bird Technologies website. All instruments returned must be shipped prepaid and to the attention of the RMA number.

Bird Service Center

30303 Aurora Road
Cleveland (Solon), Ohio 44139-2794
Fax: (440) 248-5426
E-mail: bsc@birdrf.com

For the location of the Sales Office nearest you, visit our Web site at:

<http://www.birdrf.com>

Determining VSWR Alarm Trip Point

Even though the VSWR trip point can be set to 2.5, the instrument cannot always measure VSWR above 1.9. This is due to the large amount of reflected power caused at higher VSWRs. The maximum VSWR that can be physically measured is determined by the ratio of the forward and reflected couplers at full scale. This ratio is 10:1. The maximum measurable VSWR occurs when the reflected channel is near its limit. The following table shows the maximum measurable VSWR as a function of percentage of full scale forward input power. Use this table as a guide to determine the VSWR trip point. For example, using a BPM-E 1 for the VHF low band, the full scale power measurement is 2 kW. If you are measuring a transmitter that delivers 1.7 kW (1.7 Kw is 85% of the 2 kW full scale), the maximum measurable VSWR is 2.24. If the transmitter power is reduced to 1 kW (50 % of the 2 kW full scale), then the maximum measurable VSWR is 3.00.

Percentage Full Scale	Max VSWR
50%	3.00
55%	2.82
60%	2.68
65%	2.56
70%	2.46
75%	2.38
80%	2.31
85%	2.24
90%	2.19
95%	2.14
100%	2.09

Limited Warranty

All products manufactured by Seller are warranted to be free from defects in material and workmanship for a period of one (1) year, unless otherwise specified, from date of shipment and to conform to applicable specifications, drawings, blueprints and/or samples. Seller's sole obligation under these warranties shall be to issue credit, repair or replace any item or part thereof which is proved to be other than as warranted; no allowance shall be made for any labor charges of Buyer for replacement of parts, adjustment or repairs, or any other work, unless such charges are authorized in advance by Seller.

If Seller's products are claimed to be defective in material or workmanship or not to conform to specifications, drawings, blueprints and/or samples, Seller shall, upon prompt notice thereof, either examine the products where they are located or issue shipping instructions for return to Seller (transportation-charges prepaid by Buyer). In the event any of our products are proved to be other than as warranted, transportation costs (cheapest way) to and from Seller's plant, will be borne by Seller and reimbursement or credit will be made for amounts so expended by Buyer. Every such claim for breach of these warranties shall be deemed to be waived by Buyer unless made in writing within ten (10) days from the date of discovery of the defect.

The above warranties shall not extend to any products or parts thereof which have been subjected to any misuse or neglect, damaged by accident, rendered defective by reason of improper installation or by the performance of repairs or alterations outside of our plant, and shall not apply to any goods or parts thereof furnished by Buyer or acquired from others at Buyer's request and/or to Buyer's specifications. Routine (regularly required) calibration is not covered under this limited warranty. In addition, Seller's warranties do not extend to the failure of tubes, transistors, fuses and batteries, or to other equipment and parts manufactured by others except to the extent of the original manufacturer's warranty to Seller.

The obligations under the foregoing warranties are limited to the precise terms thereof. These warranties provide exclusive remedies, expressly in lieu of all other remedies including claims for special or consequential damages. SELLER NEITHER MAKES NOR ASSUMES ANY OTHER WARRANTY WHATSOEVER, WHETHER EXPRESS, STATUTORY, OR IMPLIED, INCLUDING WARRANTIES OF MERCHANTABILITY AND FITNESS, AND NO PERSON IS AUTHORIZED TO ASSUME FOR SELLER ANY OBLIGATION OR LIABILITY NOT STRICTLY IN ACCORDANCE WITH THE FOREGOING.