



xGenius is a multi-technology Transmission / Synchronization tester equipped with an atomic Rubidium oscillator making it ideal to maintain Power Substations, 4G/5G Telecom, TV/Radio Broadcast, Finance and Air Traffic Control infrastructures.

Datasheet

Updated on 15/6/23

xGenius a new dimension

1. General

- IEEE 1588 / PTP and Synchronous Ethernet protocol emulation and analysis with advanced testing features including real time TE / MTIE / TDEV analysis and timestamped protocol capture in interfaces up to 10 Gb/s.
- ITU-T G.8272 test for PRTCs including PRTC-A and PTTC-B devices. ITU-T G.8273.2 test for T-BCs and T-TSCs including Class A and Class B devices but also Class C and Class D. ITU-T G.8273.3 and G.8273.4 tests covering T-TCs, T-BC-Ps, and T-TSC-Ps.
- Includes traffic generation and analysis features up to 10 Gb/s, equivalent to 15 millions of frames if frame size is set to 64 bytes. When connected in through mode, it accepts and forwards frames at wirespeed.
- Operation over two SFP / SFP+ compatible interfaces and two 1 Gigabit Ethernet RJ45 connectors. Each set SFP / SFP+ and RJ-45 constitutes one logical port (Port A - Port B).

- Symmetric and asymmetric automatic tests (RFC 2544, ITU-T Y.11564, RFC 6349) and synchronization tests (Synchronous Ethernet, IEEE 1588 / PTP, NTP).
- Hardware acceleration for time critical protocols such as IEEE 1588 / PTP.
- Dual port E1 / T1 generation and analysis with native support for both balanced and unbalanced signals.
- Includes support for IEEE C37.94, data communications, G.703 co-directional / contra-directional and voice frequency generation and analysis.
- Runs one-way and two-way latency tests. One-way latency uses GNSS, ToD, 1PPS or IIRIG-B timing to get accurate results.

1.1 Operation Modes

		Operation modes							
		Eth	Eth L1	T1/E1	Analog	Data	Clock	E0	C37.94
Connection	End-point	YES	YES	YES	YES	YES		YES	YES
	Monitor	YES		YES		YES	YES	YES	YES
	Pass	YES		YES		YES			YES
	Loop	YES	YES	YES					YES
	Mux Dmux			YES					

Table 1. Operation modes vs. Connection modes

- **L1 Endpoint operation:** Generation and analysis of PCS codes or any other pattern, framed or unframed required for BER testing at Layer 1.
- **Ethernet Endpoint operation:** The equipment generates and receives Ethernet PCS codes and Ethernet frames (if required to do so) in Port A and B.
- **IP Endpoint operation:** The test unit generates and receives IPv4 and IPv6 datagrams in Port A and B.
- **Through operation:** The equipment does not generate traffic. Traffic received from port A is forwarded to port B. Traffic from port B is forwarded to port A.
- **E1 / T1 Endpoint:** Emulation of a E1 / T1 network termination point including both transmission and reception.
- **E1 / T1 Loopback:** Transmits the signal received in the same port and it optionally alters the frame by adding errors, delay and adding / dropping time slots.
- **E1 / T1 Monitor:** Analysis of E1 / T1 inputs without generating any test signal.
- **E1 / T1 Pass-through:** Transfers E1 or T1 frames between ports in both transmission directions and enables test signal alteration, including symmetric or asymmetric delay generation and bit error generation.
- **E1 / T1 MUX / DEMUX:** Enables E1 / T1 and data communications at the same time to test TDM multiplexers and demultiplexers.
- **Datacom Endpoint:** Emulation of a data communications DTE or DCE.

Front Panel

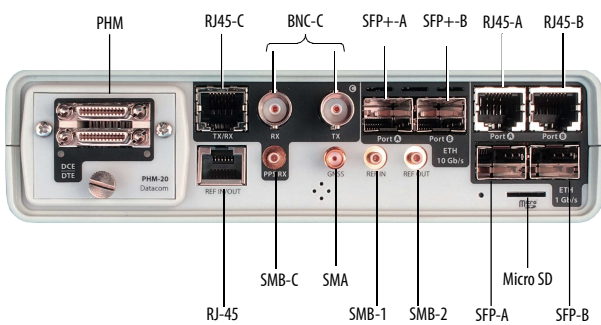

Back Panel

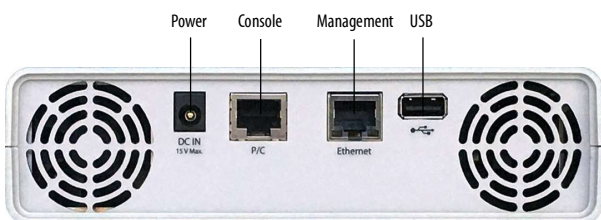

Figure 1. Ports and connectors

- Supports concurrent traffic generation and analysis over Port A and Port B, including Ethernet / IP multi-stream traffic generation and analysis, PHY / ETH / IP / UDP traffic reflection and advanced QoS analysis.

CONFIDENTIAL

- **Datcom Monitor:** Transparent, passive monitoring of a DTE to DCE connection.
- **C37.94 Endpoint:** Emulation of a IEEE C37.94 network termination point including both transmission and reception.
- **C37.94 Monitor:** Analysis of IEEE C37.94 inputs without generating any test signal.
- **C37.94 Pass-through:** Transfers IEEE C37.94 frames between ports in both transmission directions and enables test signal alteration, including symmetric or asymmetric delay generation and bit error generation.
- **C37.94 Loopback:** Transmits the signal received in the same port and it optionally alters the frame by adding errors and delay.
- **G.703 E0 Endpoint:** Generation and analysis over G.703 co-directional, contra-directional and centralized interfaces.
- **Voice Frequency:** Generation and analysis of analog signals in the telephone band (300 ~ 3400 Hz).
- **Clock Monitor:** Monitors frequency and time clock signals, including IRIG-B time codes, and runs synchronization tests on them.

1.2 Test Interface and Clock Reference Summary

	Operation modes				
	10GE	1GE	T1/E1	Clk Monitor	Cable
RJ45-A (Rx/Tx)		Ethernet, IP PTP, NTP, SyncE			Ethernet
		SyncE			SyncE
RJ45-B (Rx/Tx)		Ethernet, IP			Ethernet
		SyncE			SyncE
SFP-A (Rx/Tx)		Ethernet, IP PTP, NTP, SyncE			
		SyncE			
SFP-B (Rx/Tx)		Ethernet, IP			
		SyncE			
SFP+-A (Rx/Tx)	Ethernet, IP PTP, NTP, SyncE				
	SyncE				
SFP+-B (Rx/Tx)	Ethernet, IP				
	SyncE				
BNC-C (Rx/Tx)			E1	10 MHz 5 MHz 2048 kHz 1544 kHz	
RJ45-C (Rx/Tx)			T1/E1	10 MHz 5 MHz 2048 kHz 1544 kHz 1PPS 1PP2S ToD	
SMB-C (Rx)				1PPS 1PP2S	
SMA	GNSS	GNSS	GNSS	GNSS	GNSS
SMB-1 (in)	1PPS 1PP2S IRIG-B	1PPS 1PP2S IRIG-B	1PPS 1PP2S IRIG-B	1PPS 1PP2S IRIG-B	1PPS 1PP2S IRIG-B
SMB-2 (out)	1PPS 1PP2S IRIG-B	1PPS 1PP2S IRIG-B	1PPS 1PP2S IRIG-B	1PPS 1PP2S IRIG-B	1PPS 1PP2S IRIG-B
RJ45 (in/out)	T1/E1 10 MHz 5 MHz 2048 kHz 1544 kHz 1PPS 1PP2S ToD IRIG-B	T1/E1 10 MHz 5 MHz 2048 kHz 1544 kHz 1PPS 1PP2S ToD IRIG-B	T1/E1 10 MHz 5 MHz 2048 kHz 1544 kHz 1PPS 1PP2S ToD IRIG-B	T1/E1 10 MHz 5 MHz 2048 kHz 1544 kHz 1PPS 1PP2S ToD IRIG-B	T1/E1 10 MHz 5 MHz 2048 kHz 1544 kHz 1PPS 1PP2S ToD IRIG-B

Table 2. Native Test Interfaces and Clock References
 Clock references, Test signals







	Layout	Modes	Connectors
PHM-20		Datacom endpoint Datacom monitor Datacom loop	SS26 DCE SS26 DTE
PHM-21		IEEE C37.94 endpoint IEEE C37.94 through IEEE C37.94 monitor IEEE C37.94 loop	2 x SFP
PHM-22		G.703/E0 endpoint G.703/E0 monitor G.703/E0 loop	RJ-45
PHM-23		Analog	RJ-45 Headset
PHM-24		E1/T1 endpoint E1/T1 through E1/T1 monitor E1/T1 loop	RJ-45
PHM-25		Clk monitor (IRIG-B)	RJ-45 SMB

Table 3. Pluggable Hardware Module (PHM) Interfaces

2. Oscillator

- Default TCXO better than ± 2 ppm
- Optional OCXO better than ± 50 ppb
- Optional Rubidium better than ± 5.0 e-11

2.1 Aging

	OCXO	Rubidium
Daily	5.0e-10	2.5e-11
Monthly	-	1.0e-10
Yearly	5.0e-8	1.5e-9

Table 4. Oscillator aging

2.2 Locking time

	OCXO	Rubidium
Locking time	< 5 min	< 4 hours

Table 5. Locking time

2.3 Performance (Locked)

Reference	OCXO	Rubidium
GNSS (single-band)	± 20ns	± 15 ns
GNSS (multi-band)	± 5 ns	±5 ns

Table 6. RMS phase error

2.4 Performance (Hold-over)

	OCXO	Rubidium
Phase within ±100 ns	-	10 hours
Phase within ±500 ns	2 hours	24 hours
Phase within ±1.0 μs	4 hours	48 hours
Phase within ±10.0 μs	24 hours	-

Table 7. Holdover oscillator performance (±1 °C)

3. GNSS Synchronization Inputs

- Connector: SMA (50 Ω).
- Fixed position mode for GNSS references.
- Automatic setting of UTC-to-TAI offset (leap seconds) through GNSS.
- 4V - 5V DC output in GNSS port to feed an external antenna.
- Cable delay compensation.
- Automatic antenna detection.

3.1 Single-band Receiver

- 72-channel receiver.
- Constellations and bands: GPS L1, GLONASS L10F, BeiDou B1, Galileo E1B/C.
- Sensitivity: -166 dBm (tracking), -148 dBm (cold start).
- Single or multiple constellation selection.
- Anti-jamming technology

3.2 Multi-band Receiver

- 184-channel receiver
- Constellations and bands: GPS L1C/A, L2C, L5; GLONASS L10F; Galileo E1B/C, E5b, E5a; BeiDou B1I, B1C, B2a; NavIC L5.
- Sensitivity: -167 dBm (tracking), -148 dBm (cold start).
- Single or multiple constellation selection.
- Anti-jamming and anti-spoofing technology.

3.3 GNSS Compact Antenna

- SMA male connector
- Polarization: RHCP
- Frequency band: 1573 MHz - 1610 MHz
- Gain: 27 dB
- Noise figure: 1.5 dB
- Voltage: 2.7 V - 5.5 V
- Protection level: IP 67

4. Clock Reference Inputs

- 10 MHz, 5 MHz, 2048 kb/s, 2048 kHz, 1544 kb/s, 1544 kHz (REF IN/OUT port), Synchronous Ethernet (Port A, Port B)
- IRIG-B00X, B15X, B22X unbalanced (REF IN port) with IEEE C37.118 extensions. 50 Ω or high impedance modes. Up to 25 Vpp. AC or DC coupling.
- IRIG-B00X, B22X balanced (REF IN/OUT port) with IEEE C37.118 extensions. ITU-T V.11 electrical characteristics.
- 1 PPS, 1PP2S balanced (REF IN/OUT) and unbalanced (REF IN port) compatible with standard ITU-T G.8271. ToD balanced (REF IN/OUT) compatible with ITU-T G.8271, China Mobile and NMEA formats.
- Ethernet through Port A and Port B (over any valid electrical / optical synchronous Ethernet interface).
- Custom delay compensation for phase and time inputs.

5. Clock Reference Outputs

- 10 MHz, 5 MHz, 2048 kHz, 2048 kb/s, 1544 kb/s, 1544 kHz (REF IN/OUT port).
- IRIG-B00X, B12X, B13X, B14X, B15X, B22X unbalanced (REF OUT port) with IEEE C37.118 extensions. 50 Ω or high impedance modes. 5 Vpp. AC or DC coupling.
- IRIG-B00X, B22X balanced (REF IN/OUT port) with IEEE C37.118 extensions. ITU-T V.11 electrical characteristics.
- 1 PPS, 1 PP2S, balanced (REF IN/OUT) and unbalanced (REF OUT port) compatible with standard ITU-T G.8271. ToD balanced (REF IN/OUT) compatible with ITU-T G.8271 and NMEA.
- Custom delay compensation for phase and time outputs.

6. Ethernet PHY

- The following Ethernet interfaces are supported by the SFP / SFP+ ports: 10GBASE-SR, 10GBASE-LR, 10GBASE-ER, 10GBASE-T, 1000BASE-T, 1000BASE-SX, 1000BASE-LX, 1000BASE-ZX, 1000BASE-BX, 100BASE-FX, 100BASE-TX, 10GBASE-T.
- The following Ethernet interfaces are supported by the RJ-45 ports: 10BASE-T, 100BASE-TX, 1000BASE-T.
- Ability to enable or disable the light transmitter in optical interfaces.
- Electrical ports compliant with IEEE 802.3. Electrical isolation 1500 V (rms).
- SFP / SFP+ bay according with IEEE 802.3, Not isolated, +3.3 V (maximum).

6.1 Auto-Negotiation

- Negotiation of bit rate. Allow 10 Mb/s, allow 100 Mb/s, allow 1000 Mb/s.
- Selection of clock master or slave roles in 1000BASE-T interface.
- Ability to disable auto-negotiation and force line settings in 10 Mb/s, 100 M/s electrical interfaces and 1000 Mb/s optical interfaces.

6.2 Synchronous Ethernet

- Interfaces: 100BASE-TX and 1000BASE-T (unidirectional) through the attached RJ-45 ports. Through external SFP / SFP+:10GBASE-SR, 10GBASE-LR, 10GBASE-ER, 1000BASE-T, 1000BASE-SX, 1000BASE-LX, 1000BASE-ZX, 1000BASE-BX, 100BASE-TX, 100BASE-FX.
- Operation: Analysis of synchronous Ethernet signal in *Ethernet endpoint*, *IP Endpoint* and *IP Through modes*, generation of synchronous Ethernet signal in *Ethernet endpoint* and *IP Endpoint* modes. Transparent synchronous Ethernet pass-through in *IP Through mode*.
- Fixed frequency offset generation on transmitted signals with maximum value of ±120 ppm as per ITU-T O.174 (11/2009) 8.2.1.
- Sinusoidal wander generation on Ethernet interfaces following ITU-T O.174 Amendment 1 sections 8.4.2.1 and 8.4.2.2 and ITU-T O.174 (11/2009) section 8.4.
- Generation, decoding and transparent forwarding (*IP Through mode*) of the ESMC and the SSM code. Transmission and reception of "heart-beat" and event SSM messages is subject to ITU-T G.8264 clauses 11.3.2.1 and 11.3.2.2.
- QL to be transported by the SSM is encoded as specified in ITU-T G.781 clauses 5.5.2.1 (Option I), 5.5.2.2 (Option II) and 5.5.2.3 (Option III).

- SSM messages are generated at port level. Source MAC address is set to the local profile MAC address.

6.3 Power over Ethernet

- PoE (IEEE 802.3af-2003) and PoE+ (IEEE 802.3at-2009) detection.
- PoE interfaces: 10BASE-T, 100BASE-T and 1000BASE-TX through attached RJ-45 ports A and B.
- PoE pass-through when the equipment is configured in transparent (through) operation mode.
- PoE voltage between pairs 1-2 / 3-6 and 4-5 / 7-8 in endpoint test. Voltage and current in pairs 1-2 / 3-6 and 4-5 / 7-8 in through mode.

7. Ethernet MAC

- Ethernet MAC generation and analysis in Ethernet and IP Endpoint mode. Analysis in Ethernet / IP Through mode.
- Supported Ethernet frame formats: DIX, IEEE 802.1Q, IEEE 802.1ad.
- Support for Jumbo frames with MTU up to 10 kB.
- Setting of source and destination MAC addresses. For source MAC address, users can choose between the factory default address or a user custom address. Destination addresses can be configured as the opposite port factory default address, a single custom address or an address range. If they are specified as a range, the generated sequence will contain all the addresses within the configured range.
- Setting of the Type / Length value in ordinary Ethernet frames. Configuration of the Type value is blocked if the user sets a frame structure requiring a specific Ethernet payload type.
- Enable / disable VLAN and Q-in-Q modes. In VLAN mode, the Type / Length value is automatically set to 0x8100. In Q-in-Q mode, the Type / Length value is set to one of 0x88a8, 0x8100, 0x9100, 0x9200 or 0x9300.
- Configuration of the VLAN VID and User Priority if the VLAN encapsulation is enabled.
- In Q-in-Q mode, configuration of the S-VLAN VID, DEI and PCP. Configuration of the C-VLAN VID and User Priority.
- Configuration of the frame size.
- Insertion of FCS errors using the following insertion modes: single, burst, rate and random.

8. MPLS

- MPLS generation and analysis in IP Endpoint mode. Analysis in Ethernet / IP Through mode.
- Support of a single and double label stack (Top and Bottom with bottom of stack bit is set to 1 in Bottom label). The label is formatted as specified in RFC 3032.
- Configuration of the TTL, exp and label fields for Top and Bottom MPLS headers.
- If the MPLS block is enabled, the Type field of the MAC frame will be fixed to 0x8847 (unicast packets) or 0x8848 (multicast packets).

9. IPv4

- IPv4 generation and analysis in IP Endpoint mode. Analysis in Ethernet / IP Through mode.
- The Ethernet Type field is forced to 0x0800 value if IPv4 generation is enabled.
- Configuration of source and destination addresses. Destination addresses can be configured as the opposite port factory current address, a single custom address or an address range. If they are specified as a range, the generated sequence will contain all the addresses within the configured range.
- Configuration of destination MAC address either by hand or using ARP requests. The equipment generates ARP replies from a single, main IP address, configured in a port-specific local profile menu. All other ARP request messages are ignored.
- Configuration of DSCP CoS labels, TTL and transport protocol. If transport protocol is UDP, support of UDP frame with source and destination port configuration.
- Insertion of IP checksum errors (IP endpoint mode) using the following insertion modes: single, burst, rate and random. This event does not

produce errors in lower transmission layers. Insertion of IP checksum errors requires regeneration of the FCS field.

10. Generic / UDP Traffic Generator

- Generation over 8 independent streams. Each stream has its own specific bandwidth profile and payload / pattern configuration.
- Two independent traffic generators, one for each test port (Port A and Port B).

10.1 Bandwidth Profiles

- Traffic can be generated in four different modes: *Continuous*, *Periodic burst*, *Ramp* and *Random*.
- *Continuous* traffic is specified by a single parameter entered either as a percentage of the channel capacity, a value in b/s or a value in frames/s.
- *Periodic burst* is specified by the following values: *High traffic* (% b/s, frames/s), *Low traffic* (% b/s, frames/s), *High duration* (frames, seconds) and *Low duration* (frames, seconds).
- *Ramp* traffic is specified the following values: *High traffic* (% b/s, frames/s), *Low traffic* (% b/s, frames/s), *Steps* (integer number) and *Step duration* (seconds).
- *Random* traffic is specified by the *Poisson* average traffic as a percentage, a value in b/s or a value in frames/s.

10.2 Test Patterns and Payloads

- Layer 1 test patterns are available in *L1 endpoint* mode. All remaining patterns are available in IP endpoint and Ethernet endpoint modes.
- Layer 1 BER test patterns from IEEE 802.3-2008 Annex 36A: Long continuous random test pattern, Short continuous random test pattern.
- Layer 1 BER test patterns IEEE 802.3-2012: PRBS 2³¹-1, A-seed (LAN interfaces only), B-seed (LAN interfaces only),
- Layer 2-4 BER test patterns: PRBS 2¹¹-1, PRBS 2¹⁵-1, PRBS 2²⁰-1, PRBS 2²³-1, PRBS 2³¹-1. These patterns apply to stream 1 only.
- Test payload for SLA statistics based in the ITU-T Y.1731 vendor specific OAM payload (Layer 2 tests) or a proprietary ATSL format (Layer 3 tests). The SLA payload for Layer 2 tests configures the Ethertype field to the default value of 0x8902 (IEEE 802.1ag / ITU-T Y.1731 OAM).
- All zeros test pattern.
- Insertion of TSE (endpoint modes) using the following insertion modes: *single*, *rate* and *random* (only in bit patterns or payloads containing bit patterns). Insertion of TSE requires regeneration of FCS (and UDP CRC if configured).

11. Filter

- Up to 8 simultaneous filters per port can be applied to the traffic.
- The decision of which branch is in charge of processing traffic is taken for each individual frame using one or several filters. Each frame is processed by one and only one branch. If there is a conflict, the branch with smaller index has precedence.
- Selection is done by using the Ethernet frame fields. If the Ethernet frame carries IP it is possible to select frames by the IP header fields. In such cases when the Ethernet frames carry IP traffic it is possible to select frames by the contents of higher level protocols of the TCP/IP stack.
- The equipment supports a generic filter which can select frames by using a 16 bit mask and an arbitrary offset defined by the user.

11.1 Ethernet Selection

- By source and destination MAC addresses. Selection of MAC address sets with masks.
- By Type / Length value with selection mask.
- By C-VID and S-VID with selection mask.
- By Service and Customer priority code-point value with selection mask.

11.2 MPLS Selection

- Separated filters to account for the Top and Bottom MPLS headers.
- By label value. Specific option for selection of label ranges.
- By the value of the Exp field with specific option for selection of ranges.

11.3 IPv4 Selection

- Selection by IPv4 source or destination address. Or both at the same time. It is possible to select address sets by using masks.

- Selection by protocol as defined in the IPv4 datagram protocol field.
- Selection by the DSCP fields, it is possible to filter single DSCP values or DSCP value ranges.

11.4 IPv6 Selection

- Selection by IPv6 source or destination address (or both at the same time). It is possible to select address sets by using masks.
- Selection by IPv6 flow label. Selection based on the next header field value. Selection by DSCP.

11.5 UDP / TCP Selection

- Selection by UDP and TCP port. Either single value filters or filtering of port ranges is available.

11.6 Protocol Selection

- Selection by protocol applying to the following protocols: IEEE 1588-2008 over Ethernet, IEEE 1588-2008 over IPv4, NTP, IEEE 61850 GOOSE and SV.
- Selection by Domain, Port Identity and Message Type (*Sync, Delay Request, Delay Response, Peer Delay Request, Peer Delay Response, Follow up, Peer Delay Follow up, Announce, Signaling, Management*) when the selected protocol is IEEE-1588.
- Packet filtering based on NTP message type (*Symmetric active, Symmetric passive, Client, Server, Broadcast, Control, Other*) when the selected protocol is NTP.
- Selection by APPID when the protocol is IEC 61850.

12. PTP / IEEE 1588

- PTP emulation and testing in Ethernet and IP Endpoint modes (Port A and B).
- Support of hardware-assisted generation and decoding of Precision Time Protocol (PTP) as defined in IEEE 1588-2008.
- Encapsulations: PTP over UDP over IPv4 (IP Endpoint mode) as defined in IEEE 1588-2008 Annex D, PTP over IEEE 802.3 / Ethernet as defined in IEEE 1588-2008 Annex F.
- Compatible with unicast, multicast and hybrid transmission with UDP and Ethernet payloads. Supports unicast negotiation.
- Support of 1-step and 2-step clock modes both in slave or master emulation.
- Support of peer-to-peer and end-to-end delay mechanisms.
- Configuration of Domain, Priority 1, Priority 2, Clock class, forwardable / non-forwardable multicast MAC address, PTP accuracy and PTP variance. Configuration of announced capabilities: UTC offset, time and frequency traceability, timescale and time source.
- Setting of message rates for Sync, Delay Request, Peer Delay Request and Announce messages. Configuration of Announce message timeout.

12.1 PTP Test modes

- *Sync analyzer*: Single PTP instance and four different *Clock emulation* modes: *Test, Slave, Master* and *Auto*.
- *Dual sync analyzer*: One PTP *test* instance attached to each Ethernet port. Measures timing performance in each port and it also provides differential statistics between them.
- *BC / TC test*. One PTP instance attached to each Ethernet port. One of the instances runs in *master* mode and the second in *test* mode. It enables accurate measurements in Boundary Clocks, Transparent Clocks and other multi-port devices
- *SC test*. One PTP instance in one of the Ethernet ports running in *master* emulation mode and one clock analysis instance. It enables accurate measurements in PTP slave clocks.

13. NTP

- NTPv3 / NTPv4 server and client emulation. Test mode to verify performance of NTPv3 / NTPv4 servers.
- Support of hardware-assisted time stamping for Network Time Protocol (NTP).
- Configuration of protocol version, server address (IP address or domain name) and polling interval in client emulation and test modes

- Configuration of protocol version, stratum level and reference id in master emulation mode.

14. PHY Results

14.1 Cable Tests

- For inactive links: Open/short fault indication and distance to fault in meters (accuracy: 1 m).
- For 10/100 Mb/s active links, the following results are reported: current local port MDI/MDI-X status.
- For 1 Gb/s active links the following results are reported: current local port MDI/MDI-X status, pair polarities (normal/inverted), pair skew (ns).

14.2 SFP

- SFP presence, current interface, vendor, and part number.
- Optical power measurement (transmitted and received power) over compatible SFP transceivers.

14.3 Auto-Negotiation

- Auto-negotiation results with current bit rate and duplex mode.
- For 1000BASE-T indication of clock *Master* and *Slave* roles

14.4 Synchronous Ethernet

- Measurement of the line frequency (MHz), frequency offset (ppm) and frequency drift (ppm/s) as specified in ITU-T O.174 (11/2009) clause 10.
- TIE / MTIE / TDEV measurement on Ethernet interfaces following ITU-T O.172 clause 10.
- Decoding of the QL transported in SSM as per ITU-T G.781 clauses 5.5.3.1 (Option I), 5.5.3.2 (Option II) and 5.5.3.3 (Option III).

15. Frame Analysis

- Simultaneous per port statistics.

15.1 Ethernet Statistics

- Frame counts: Ethernet, IEEE 802.1Q (VLAN), IEEE 802.1ad frames, Q-in-Q frames, control frames, pause frames.
- Frame counts: unicast, multicast and broadcast.
- Basic error analysis: FCS errors, undersized frames, oversized frames, fragments, jabbers.
- Frame size counts: 64 or less, 65-127, 128-255, 256-511, 512-1023, 1024-1518, 1519-1522, 1523-1526 and 1527-MTU bytes.

15.2 MPLS Statistics

- MPLS stack length: minimum, maximum.

15.3 IP Statistics

- Packet counts: IPv4 packets, IPv6 packets.
- Packet counts: unicast, multicast and broadcast.
- TCP packets, UDP packets, ICMP packets.
- IPv4 checksum errors, IPv6 checksum errors.
- UDP and TCP checksum errors.

15.4 Bandwidth Statistics

- Simultaneous per port and per stream statistics
- Current, maximum, minimum Ethernet traffic expressed in bits per second, frames per second and a percentage of the nominal channel capacity.
- Ethernet unicast, multicast and broadcast traffic expressed as a percentage of the nominal channel capacity.
- IPv4 and IPv6 statistics expressed in bits per second, frames per second and a percentage of the nominal channel capacity.
- UDP traffic expressed in bits per second, frames per second and a percentage of the nominal channel capacity.

15.5 SLA Statistics

- Simultaneous per stream and per port statistics.
- Delay statistics are provided by means the point-to-point Ethernet frame transfer delay (FTD): current, minimum, maximum, and mean values. FTD statistics follow definitions given in ITU-T Y.1563
- Delay variation statistics are provided by the following statistics: standard deviation of the FTD, peak FDV (difference between maximum FDV

and minimum FDV), current jitter (smoothed value of the jitter following RFC 1889 and RFC 3393), maximum jitter, mean jitter.

- Frame reordering and duplication statistics (RFC 5236): Out-of-order frames, Out-of-order frame ratio, duplicated frames, duplicated frame ratio.
- Frame loss statistics to be used is the lost frames count and the 2-way Ethernet Frame Loss Ratio (FLR).
- Availability statistics: Severely Errored Seconds (SES) count, Percent Ethernet service Unavailability (PEU), Percent Ethernet service Availability (PEA).

15.6 Service Disruption Time

- Simultaneous per port statistics. Analysis carried out over flow 1 statically.
- Service Disruption test based on the analysis of the SLA pattern carried by a synthetic traffic flow.
- Resolution is 1 ms.
- Statistics are service disruption events count. Total disrupted time. Average, minimum and maximum time in a service disruption event. Time in the last disruption event.

15.7 BER

- Simultaneous per port statistics. Analysis carried out over flow 1 statically.
- Bit error count, seconds with errors, bit error ratio (BER).
- Pattern losses, pattern loss seconds.

15.8 Network Exploration

- Simultaneous per port results for a single search field.
- Top talkers statistics: Displays the 16 most common source MAC addresses (Ethernet Endpoint mode) or source MAC / IPv4 / IPv6 addresses (IP Endpoint mode).
- Top VID (IEEE 802.1Q) statistics: Displays the 16 most common VID tags.
- Top S-VID (IEEE 802.1ad) statistics: Displays the 16 most common S-VID tags.
- Automatic setup of the eight available filtering blocks to match the items found in the top talkers list.

16. PTP / IEEE 1588 Statistics

- Two-way TE and max |TE| measurement.
- Constant (cTE), slow (d^LTE) and fast (d^HTE) TE statistics.
- Relative TE statistics measured between test ports.
- *Wander metrics*: TIE (ITU-T G.8260 *pkfilteredTIE*), MTIE (ITU-T G.8260 *pkfilteredMTIE*) and TDEV (ITU-T G.8260 *pkfilteredTDEV*).
- Protocol state details: port state, best master clock protocol state, master identity, grandmaster identity, grandmaster BMC priorities, grandmaster clock class, grandmaster accuracy, grandmaster clock variance, grandmaster time source, master IP or Ethernet address
- Sync floor delay packet population metrics (ITU-T G.8260): *Sync Floor Packet Count* (FPC), *Floor Packet Rate* (FPR) and *Floor Packet Percent* (FPP). Configurable Pass / Fail threshold for FPP performance metric.
- Frequency offset measurement.
- Master-to-slave delay, slave-to-master delay, round round trip delay and delay asymmetry statistics.
- *Sync Inter Arrival time* analysis: Average and current.
- TX and RX PTP frame counts classified by frame type: *Sync*, *Delay request*, *Delay response*, *Peer delay request*, *Peer delay response*, *Follow up*, *Peer delay response follow up*, *Announce*, *Signaling*, *Management*.
- *Correction field statistics*: current, maximum and average.

17. NTP Statistics

- Protocol status: *Port state*, *Stratum*, *Reference id*, *Polling interval*, *Root delay*, *Root dispersion*, *Leap status*, *Time*.
- Message statistics. Count of transmitted and received *Symmetric active*, *Symmetric passive*, *Client*, *Server*, *Broadcast*, *Control* and *Other* packet types.
- Delay statistics. Displays current value, mean, range and standard deviation of the following parameters: *Offset (theta)*, *Delay (delta)*, *Forward*

path delay, *Return path delay*, *Asymmetry* Displays current value, mean and range of the *Jitter (psi)*.

- Two-way TE statistics. Computes the following TE statistics: current value, mean, minimum, maximum, standard deviation.

18. IEC 61850 GOOSE

- Decodes and analyzes GOOSE frames encoded as specified in IEC 61850-7-2 and 61850-8-1.
- GOOSE protocol scan with GoCBName, Gold, DatSet.
- GOOSE frame count for the active flow and all flows.
- Latency analysis: current, average, minimum, maximum, range and standard deviation computed over the active flow.

19. IEC 61850 SV

- Decodes and analyzes SV frames encoded as specified in IEC 61850-7-2 and 61850-9-2.
- SV protocol scan with svID population and selection of the active flow.
- SV frame count for the active flow and all flows.
- Sample count and sampling rate measurement for the active flow.
- Latency analysis: current, average, minimum, maximum, range and standard deviation computed over the active flow.

20. Automatic Tests

- The equipment supports automatic normalized tests defined in IETF RFC 2544 and ITU-T Y.1564.
- Custom pass / fail objectives.
- User configurable analysis port in symmetric tests.
- Static Port A operation in asymmetric tests.

20.1 IETF RFC 2544 Test

- Compatible with Ethernet Endpoint and IP Endpoint modes.
- Support throughput, frame-loss, latency, back-to-back and recovery time tests.

20.2 ITU-T Y.1564 Test

- Supports the Ethernet service activation methodology defined in ITU-T Y.1564 when the equipment is configured in Ethernet Endpoint and IP Endpoint modes.
- Testing of up to eight services (non-color aware mode) or up to four services (color aware mode) with configuration of the *CIR*, and *EIR* for each of them.
- Configuration of *frame delay* (FTD), *frame delay variation* (FDV), *frame loss ratio* (FLR) and availability objectives for each service to be verified.
- Settings for test phase 1 (Network Configuration Test) are *Steps* (integer number) and *Step duration* (seconds). Settings for phase 2 (Ethernet Service Test) are the *Phase duration* and *bandwidth profile* (*deterministic*, *random*).
- The test bandwidth profile for test phase 1 is a modified ramp where the *CIR*, *EIR* and *maximum throughput* rates are forced and the other transmission rates are derived from the *Steps* setting. For phase 2, the test bandwidth profile is deterministic / random generated at the CIR bit rate for all services at the same time.
- The FTD, FDV (mean value) and FLR is measured for each step in phase 1 and phase 2 and a pass / fail indication is computed for each step. Phase 1 fails if there is at least one failed result in this phase. Phase 2 does not start is phase 1 fails.

20.3 IETF RFC 6349 Test

- Operation modes: active (client) or passive (server).
- Accepted endpoints in client mode: Albedo and IPerf3.
- Allows user configuration of the MTU and MSS.
- User configuration of the Bottleneck Bandwidth (BB) in frames/s or as a percentage of the nominal link capacity.
- Measurement of the Round-Trip Time (RTT) based on the mechanism described in RFC 2544 through a single UDP stream.
- Window sweep test at four different window sizes: 25%, 50%, 75% and 100% of the BDP.
- Measurement of the Transfer Time ratio, TCP Efficiency and Buffer delay as defined in RFC 6349 4.1, 4.2 and 4.3.

21. Port Loopback

- Layer 1-4 loopback.
- Loop frames matching current filtering conditions or loop all frames.
- Loop controls for broadcast and ICMP frames.

22. ICMP Processor (Ping / Traceroute)

- Generation of on demand ICMP echo request (RFC 792) messages with custom destination IP address, packet length and packet generation interval.
- Analysis of ICMP echo reply (RFC 792) messages with measurement of round trip time and lost packets.
- Analysis of *ICMP Time-To-Live Exceeded* and *ICMP Port unreachable* replies received in the traceroute test.

23. Protocol Processor

- IPv4 ARP (IETF RFC 826) for automatic resolution of remote MAC address in IP Endpoint mode (IPv4 network protocol).
- IPv4 destination address resolution through DNS (IP Endpoint mode).
- DHCP (client side) (IETF RFC 2131) for IPv4 profile auto-configuration or static IPv4 profile configuration.
- Support of the Trace-route application over IPv4 using UDP packet transmission with increasingly higher TTL values. Support of the Trace-route application over IPv4 using ICMP echo request packets with increasingly higher TTL values.

24. Protocol Analysis

- Simultaneous per filter and per port capture. Each packet is marked by the capture filter so that this filter could be identified at a later stage.
- Capture of received streams (port A) in endpoint configurations.
- Capture of received streams (port A) in pass-through configurations at all speeds.
- Storage capacity: 256 MB.
- Wrap around mode for continuous captures.
- Export results to PCAP and PCAPNG formats.
- Hardware time stamping of captured packets. Resolution is 1 ns.
- Supports UTC time stamps when is connected to an external time clock reference input (GNSS, ToD or IRIG-B) or in holdover.
- Decoding of the following protocols mapped over Ethernet: *SLA payload* (ALBEDO proprietary), *ESMC*, *ARP* and *Pause*.
- Decoding of the following protocols mapped over IP: *SLA payload* (ALBEDO proprietary), *NTP*, *IGMP*, *DHCP*, *DNS* and *ICMP*.
- Decoding of PTP over Ethernet and PTP over IP /UDP. Decoding of IEC 61850 *GOOSE* and *SV* protocols over Ethernet.
- Packet-by-packet latency measurements for the following protocols: *SLA payload* (ALBEDO proprietary), IEEE 1588-2008, *NTP*, IEC 61850 *GOOSE*, IEC 61850 *SV*.

25. E1 Generation / Analysis

25.1 Connectors

- Unbalanced (BNC) 75 Ω.
- Dual Balanced (RJ-48) 120 Ω.

25.2 Line

- Configurable input impedance: nominal line impedance, PMP 20 dB, PMP 25 dB, PMP 30 dB, high impedance (> 1000 Ω).
- Custom transmission clock: recovered or synthesized
- Configurable output frequency offset within ±25,000 ppm around the nominal frequency.
- Line codes: HDB3, AMI.
- Input Level: From 0 dB to -45 dBm.
- Pulse mask compliance: ITU-T G.703.
- Jitter compliance: ITU-T G.823.

25.3 Frame

- 2 Mb/s unframed, ITU-T G.704, ITU-T G.704 CRC, ITU-T G.704 CAS, ITU-T G.704 CRC + CAS.
- *Nx64* kb/s generation and analysis in contiguous and non-contiguous time slots.

- Generation of custom NFAS spare bits (ITU-T G.704 frame with CRC-4 multi-frame).
- CAS A, B, C, D bit generation for each voice channel. Generation of CAS multi-frame spare bits (ITU-T G.704 frame with CAS multi-frame).
- Custom *Synchronization Status Message* (SSM) generation.

25.4 Line Analysis

- Line attenuation (dB).
- Frequency (Hz), frequency deviation (ppm).
- Custom pass / fail indications

25.5 Frame and Pattern Analysis

- Defects: LOS, LOF, AIS, RDI, CRC-LOM, CAS-LOM, MAIS, MRDI, LSS, All 0, All 1, Slip.
- Anomalies: Code, FAS error, CRC error, REBE, MFAS error, TSE, TSBE.
- ITU-T G.821 performance: ES, SES, UAS, DM. ITU-T G.821 results include pass / fail indications.
- ITU-T G.826 performance: ES, SES, UAS, BBE (near and far end statistics). ITU-T G.826 results include pass / fail indications.
- ITU-T M.2100 performance: ES, SES, UAS, BBE (near and far end statistics). ITU-T M.2100 results include pass / fail indications.
- Channel map and time slot analysis: time slot value in hexadecimal and binary formats, time slot level and frequency computed following the ITU-T G.711 A law.
- FAS / NFAS word analysis.
- CAS A, B, C, D bit analysis.
- Synchronization Status Message (SSM) decoding and analysis.

25.6 Event Insertion

- Physical: Code, AIS, LOS, bit error, delay.
- Frame: FAS error, CRC error, MFAS error, REBE, LOF, MAIS, CAS-LOM, RDI, MRDI, CRC-LOM.
- Pattern: TSE, Slip, LSS, All 0, All 1.
- Insertion modes: Single (anomalies), rate (anomalies), continuous (defects), M-single (defects), MN-repetitive (defects).

26. T1 Generation / Analysis

26.1 Connectors

- Dual Balanced (RJ-48) 120 Ω.

26.2 Line

- Configurable input impedance: nominal line impedance, PMP 20 dB, PMP 25 dB, PMP 30 dB, high impedance (> 1000 Ω). Cable delay equalization up to a 6 dB attenuation.
- Custom transmission clock: recovered or synthesized
- Configurable output frequency offset within ±25,000 ppm around the nominal frequency.
- Line codes: B8ZS, AMI.
- Input Level: From 0 dB to -45 dB.
- Pulse mask compliance: ANSI T1.102-1999, ITU G.703.
- Jitter compliance: ANSI T1.102-1999, ITU-T G.823.

26.3 Frame

- 1544 kb/s unframed, SF (D4) and ESF in accordance with ANSI T1.403-1999 and ITU-T G.704.
- *Nx64* and *Nx56* kb/s generation and analysis in contiguous and non-contiguous time slots with and without 'robbed bit' signaling.
- CAS A, B, C, D bit generation for each voice channel through the 'robbed bit' mechanism.
- Generation of custom FDL word (ESF frame format).
- Custom *Synchronization Status Message* (SSM) generation.

26.4 Line Analysis

- Line attenuation (dB).
- Frequency (Hz), frequency deviation (ppm).
- Custom pass / fail indications

26.5 Frame and Pattern Analysis

- Defects: LOS, LOF, AIS, RDI, LSS, All 0, All 1, Slip.
- Anomalies: Code, FAS error, CRC error, TSE.

- ITU-T G.821 performance: ES, SES, UAS, DM with pass / fail indications.
- ITU-T G.826 performance: ES, SES, UAS, BBE (near and far end statistics) with pass / fail indications.
- ITU-T M.2100 performance: ES, SES, UAS, BBE (near and far end statistics). with pass / fail indications.
- Channel map and time slot analysis: time slot value in hexadecimal and binary formats, time slot level and frequency computed following the ITU-T G.711 μ law.
- CAS A, B, C, D bit analysis.
- FDL analysis (ESF frame format).
- Synchronization Status Message (SSM) decoding and analysis.

26.6 Event Insertion

- Physical: AIS, LOS, bit error, delay.
- Frame: FAS error, CRC error, LOF, RDI.
- Pattern: TSE, Slip, LSS, All 0, All 1.
- Insertion modes: Single (anomalies), rate (anomalies), continuous (defects), burst of M (defects), M out of N (defects).

27. Data Communications

- Operation: DTE emulation, DCE emulation and full duplex monitor.

27.1 Connectors

- Smart Serial universal data communications connector for the DTE and DCE (all interfaces).

27.2 Interfaces

- V.24 / V.28 asynchronous from 50 b/s to 128 kb/s.
- V.24 / V.28 synchronous from 50 b/s to 128 kb/s.
- X.21 / V.11 asynchronous from 50 b/s to 128 kb/s.
- X.21 / V.11 synchronous from 50 b/s to 10 MHz.
- V.35 from 50 b/s to 10 MHz.
- V.36 (RS-449) from 50 b/s to 10 MHz.
- EIA-530 from 50 b/s to 10 MHz.
- EIA-530A from 50 b/s to 10 MHz.

27.3 Line

- Clock circuit selection (TC or TTC) in V.24 / V.28 synchronous, V.35, V.36, EIA-530 and EIA-530a interfaces.
- Configurable output frequency offset within $\pm 25,000$ ppm around the nominal frequency.
- Data bits, stop bits, parity and inter-word gap configuration in V.24 and X.21 / V.11 asynchronous interfaces.
- Configuration of input and output data-to-clock phases to 0°, 90°, 180° and 270°.

27.4 Line Analysis

- Frequency (Hz), frequency deviation (ppm).
- Received character count (V.24 asynchronous).
- RD-to-RC phase (°) in datacom monitor and DTE emulation modes (synchronous interfaces).
- TD-to-TC and TD-to-TTC phases (°) in datacom monitor and DCE emulation modes (synchronous interfaces).
- Logic analyser capability for data, clock and control circuits with custom setting of control circuits.

27.5 Clock and Pattern Analysis

- ITU-T G.821 performance: ES, SES, UAS, DM. ITU-T G.821 results include pass / fail indications.
- Defect insertion and analysis: LOC, AIS, LSS, All 0, All 1.
- Anomaly insertion and analysis: TSE, Slip.

28. IEEE C37.94

28.1 Connectors

- Dual port operation over SMF or MMF with suitable SFP.

28.2 Line

- Transmission clock: Recovered or internally synthesized.
- Laser on and off control.

28.3 Frame

- Unframed or framed operation.
- Frame structure follows IEEE C37.94 section 4.1.
- Configurable bit-rate between 64 kb/s and 768 kb/s in steps of 64 kb/s.

28.4 Line Analysis

- Frequency (Hz), frequency deviation (ppm).
- Transmitted optical power (dBm), received optical power (dBm).
- Received data rate (kb/s).
- SFP information: transceiver, vendor, model and wavelength.

28.5 Frame and Pattern Analysis

- ITU-T G.821 performance: ES, SES, UAS, DM. ITU-T G.821 results include pass / fail indications.
- Event detection and insertion: LOS, AIS, FAS, RDI (yellow), LSS, ALLO, ALL1, Slip, TSE, bit error, delay.

29. E0 Generation and analysis

- G.703 co-directional, contra-directional and centralized interface operating at 48 kb/s, 56 kb/s, 64 kb/s, 72 kb/s, 128 kb/s, 144 kb/s, 192 kb/s, 256 kb/s.
- Custom transmission clock: recovered or synthesized.
- Configurable output frequency offset within $\pm 25,000$ ppm around the nominal frequency.

29.1 Line Analysis

- Frequency (Hz), frequency deviation (ppm).

29.2 Pattern Analysis

- ITU-T G.821 performance: ES, SES, UAS, DM. ITU-T G.821 results include pass / fail indications.
- Defect insertion and analysis: LOS, AIS, LSS, 0s, 1s.
- Anomaly insertion and analysis: TSE, Slip.

30. Patterns and Signals

- *PRBS 6, PRBS 7, PRBS 9* (ITU-T 0.150, 0.153), *PRBS 11* (ITU-T 0.150, 0.152, 0.153), *PRBS 15* (ITU-T 0.150, 0.151), *PRBS 20* (ITU-T 0.150, 0.153), *PRBS 23* (ITU-T 0.150, 0.151), *PRBS 6 inverted, PRBS 7 inverted, PRBS 9 inverted, PRBS 11 inverted, PRBS 15 inverted, PRBS 20 inverted, PRBS 23 inverted, QRSS, QRSS inverted, QBF / FOX, all 0, all 1*.
- User configurable 32 bit word.
- Tone (from 10 Hz to 4000 Hz, from +6 dBm to -60 dBm) (E1 and T1 interfaces only).

31. Voice Frequency Test

- Tone generation and analysis function. Configurable level between -60 dBm and +3 dBm in steps of 0.1 dB. Configurable frequency between 2 Hz and 4000 Hz in steps of 1 Hz.
- Measurement of *Signal level (dBm), Noise level (dBm), Signal Frequency (Hz)*
- Sensitivity: -60 dBm (signal measurements), -80 dBm (noise measurements).
- ITU-T G.711 analysis: maximum code, minimum code, average code.
- Frequency sweep test with up to 8 user configurable frequencies with custom gain / loss threshold for each of them.

32. Clock Monitor

- Frequency inputs: 2048 kHz, 1544 kHz, 5 MHz, 10 MHz in RJ-48 (120 Ω) or BNC (75 Ω) connectors.
- Time inputs: 1PPS and 1PP2S over SMB (50 Ω) or RJ-48 (120 Ω), ToD (ITU-T G.8271, China Mobile, NMEA) over RJ-48 (120 Ω). IRIG-B00X, B12X, B13X, B14X, B15X, B22X over SMB (50 Ω , 600 Ω). IRIG-B00X, B22X in RJ-48 (120 Ω).
- Configurable input impedance in unbalanced IRIG-B and frequency interfaces (1544 kHz, 2048 kHz, 5 MHz, 10 MHz): nominal line impedance, PMP 20 dB, high impedance (> 1000 Ω).
- Configuration of IRIG-B modulation type: pulse width code, amplitude modulated, Manchester modulated.

- IRIG-B12X carrier frequency (amplitude modulated signals): 1 kHz, 10 kHz, 100 kHz, 1 MHz.
- Amplitude in unbalanced IRIG-B00X and B22X interfaces: 3.3V, 5V.
- Gain in unbalanced IRIG-12X, 13X, 14X and 15X interfaces: 0 dB, 6 dB, 12 dB, 18 dB.

32.1 Line Analysis

- Line attenuation (dB) for frequency inputs.
- Duty cycle for 1PPS and 1PP2S.
- Frequency (Hz), frequency deviation (ppm) for frequency inputs.

32.2 IRIG-B Frame Analysis

- Detection of the coded expression format
- Decoding of BCD_{TOY} and BCD_{YEAR}. Consistency check with SBS.
- Recording of LSP, LS, DSP, DST with details about the time they have been remained active.
- Decoding of CF fields: *Time Offset*, *Time Quality* and *Continuous Time Quality*.
- Detection of a *Parity* anomaly.

33. Pulse Mask Analysis

- Interfaces: E1, T1.
- Operation modes: Eye diagram or continuous run.
- Display of positive, negative and positive / negative pulse.
- Measurement of pulse width, rise time, fall time, level, overshoot and undershoot (positive and negative pulses).
- Pass / fail indication for compliance with ANSI T1.101-1999 and ITU-T G.703 1544 kb/s mask.

34. Jitter and Wander Generation

- Interfaces: E1 (primary port), T1 (primary port), IEEE C37.94.
- Modulation waveform: sinusoidal.
- Modulation frequency range: 1 μHz to 100 kHz.
- Modulation frequency resolution: 0.1 Hz (jitter), 1 μHz (wander).
- Modulation amplitude: 0 ~ 1000 UIpp. Maximum depends on modulation frequency as specified in ITU-T 0.171 and 0.172.
- Modulation amplitude resolution: 1 mUIpp or 1/10⁴ of the configured value.
- Smooth amplitude changes in jitter range (10 Hz ~ 100 kHz).
- Intrinsic jitter < 10 mUIpp.

35. Jitter Analysis

- Interfaces: E1 (primary port), T1 (primary port), 2048 kHz, 1544 kHz, IEEE C37.94.
- Closed loop phase measurement method.
- Modulation frequency range: 0.1 Hz to 100 kHz (locking time 10 s), 1 Hz to 100 kHz (locking time 1 s), 10 Hz to 100 kHz (locking time < 1 s).
- Modulation amplitude: 0 to 1000 UIpp (single range). Maximum amplitude depends on modulation frequency as specified in ITU-T 0.171 and 0.172.
- Modulation amplitude resolution: 1 mUIpp.
- Measurement accuracy: better than ITU-T 0.172.
- Jitter measurement results: peak to peak jitter, RMS jitter, maximum jitter, hits detection and count (user selectable threshold).
- Jitter measurement observation time: 1 s, 10 s, 60 s.
- E1 / 2048 kHz / IEEE C37.94 measurement filters (ITU-T G.703): LP (f < 100 kHz), LP+HP1 (20 Hz < f < 100 kHz), LP+HP2 (18 kHz < f < 100 kHz), LP+RMS (12 kHz < f < 100 kHz).
- T1 / 1544 kHz measurement filters (ANSI T1.102 T1): LP (f < 40 kHz), LP+HP1 (10 Hz < f < 40 kHz), LP+HP2 (8 kHz < f < 100 kHz).

36. Wander Analysis

- Interfaces: E1 (primary port), T1 (primary port), 2048 kHz, 1544 kHz, 5 MHz, 10 MHz, 1 PPS, 1PP2S, ToD, IEEE C37.94, IRIG-B.
- Open loop measurement method.
- Modulation frequency range: 1 μHz to 10 Hz.
- Wander sampling frequency: 50 Hz.
- Modulation amplitude: 0 to ±2 s (single range).

- Modulation amplitude accuracy: 2 ns.
- Statistics range: 10², 10³, 10⁴, 10⁵, 10⁶ s.
- TIE analysis in E1, T1, 2048 kHz, 1544 kHz, 10 kHz and IEEE C37.94. TIE analysis in PPS (module 1 second), ToD and IRIG-B interfaces with minimum and maximum records.
- Frequency offset, frequency drift with maximum records.
- Built in real time TIE, MTIE, TDEV (ITU-T G.810)
- MTIE and TDEV resolution: 100 ps.
- Custom MTIE and TDEV pass / fail indication based on standard masks.

37. Latency

- Interfaces: E1 (primary port), T1 (primary port), IEEE C37.94, data communications, G.703 co-directional, G.703 contra-directional, G.703 centralized, voice frequency.
- One way and two way modes.
- Results: round trip delay, forward path delay, reverse path delay, asymmetry with minimum and maximum records.
- Remote end identification in one way tests.
- Clock sources for one way tests: GNSS and ToD.
- Patch cord delay compensation.
- Custom pass / fail indications.

38. Port Loopback

- Interfaces: E1, T1, IEEE C37.94.
- Independent loopback control for each port.
- Custom latency generation up to 50 ms.

39. Service Disruption Time

- Interfaces: E1, T1, IEEE C37.94, data communications, G.703 co-directional, G.703 contra-directional, G.703 centralized.
- Resolution is 100 μs or the smaller resolution allowed by the detection / clearance rules.
- Statistics are service disruption events count. Total disrupted time. Average, minimum and maximum time in a service disruption event. Time in the last disruption event.

39.1 In-service triggers

- LOS with detection / clearance following ITU-T G.775 clause 4.2 (E1), ITU-T G.775 clause 4.3 (T1) and IEEE C37.94-2017 clause 5.1 (IEEE C37.94).
- AIS with detection / clearance following ITU-T G.775 clause 5.2 (E1), ITU-T G.775 clause 5.4 (T1).
- LOC with detection / clearance following ITU-T G.775 clause 4.1 applied to the receiving clock circuit (datacom synchronous).
- RDI with detection / clearance following ITU-T G.775 clause 6.2 (E1) and IEEE C37.94 clause 5.3 (IEEE C37.94).

40. Out of service triggers

- TSE with detection / clearance following ITU-T 0.150 clause 4.2 modifying the integration period to the shortest of 64 bits or 100 μs.
- 1s and 0s with detection / clearance following ITU-T 0.150 clause 4.2 modifying the integration period to the shortest of 64 bits or 100 μs.

41. Platform

- Size: 260 x 160 x 63 mm.
- Weight: 1.9 kg (two battery packs).
- Screen: 8 inch, TFT color (800 x 480 pixels).
- USB type A port, according USB standard 2.0, DC output: +5 V / 0.5 A (max).
- RS-232 / V.24 console port for maintenance tasks.
- Ethernet (10/100BASE-T) and WiFi (802.11a/b/g/n) management. WiFi operation requires an external dongle.

41.1 Power Specifications

- Operation time with batteries (LiPO): 5 ~ 8 hours.
- Battery recharge time (LiPO): 4 hours.
- DC input, 12 V (nominal), 15 V (maximum) / 5 A (maximum).

- External AC power adapter 100 - 240 V ~50 / 60 Hz, 1.5 A. Output 12 V DC, 5 A.
- AC power grid fluctuations < ±10% of the nominal voltage
- Overvoltage category II

41.2 **User Interface**

- Graphical user interface controlled by touch-screen, keyboard or mouse.
- Web based report and configuration file management.
- Full remote control: SNMP or VNC.

41.3 **Results**

- Report generation in PDF format.
- File transfer to SD card and USB port.
- File management through web interface and SNMP.
- Configuration and report storage and export through attached USB port.

41.4 **Operational Ranges**

- Operational range: -10°C to +45°C.
- Storage range: -20°C to +70°C.
- Operation humidity: 5% - 95%.
- Height: Up to 3000 m above the sea level.
- Pollution degree II
- Dust and rain protection: IEC 60529:2001, IP54.
- Vibration: IEC 60028-2-6 (10~500 Hz, 0.35 mm).
- Shock: IEC 60028-2-27 (150 m/s², 11 ms, half-sine pulse).

42. **Ordering Information**

Code	Description
XGENIUS.HHE	Battery operated. 1 Gb/s Ethernet tester with optional 10 Gb/s Ethernet, E1/T1 and synchronization capabilities. Includes dual 10/100/1000 Mb/s electrical ports, dual SFP+ ports. QoS statistics, RFC2544 and eSAM (Y.1464) performance tests, L1-L4 BER test, continuous / burst / ramp / random multi-stream traffic generation, traffic statistics, error analysis, connectivity test ('ping', 'traceroute'), multiple analysis filters, event insertion, endpoint and pass-through operation modes, graphical display of events, report generation and export.
XGENIUS.10GO	Adds 10GBASE-SR, 10GBASE-LR and 10GBASE-ZR interfaces.
XGENIUS.10GE	Adds 10GBASE-T interface.
XGENIUS.ETHDUAL	Adds autonomous and simultaneous traffic generation capabilities to both Ethernet ports.
XGENIUS.6349	Computes TCP throughput, efficiency and buffer delay over single or multiple TCP connections following the methodology defined in RFC 6349. This test requires either one unit with two test ports connected to the transmission path ends or two compatible test units each of them installed at the ends of the transmission path.
XGENIUS.IPV6	Decoding and analysis of IPV6 datagrams. IPV6 traffic statistics and events. IPV6 packet filtering. TOP IPV6 source and destination addresses (with Network search option).
XGENIUS.MPLS	Generation of single or double MPLS label according RFC 3032. Configuration of TTL, Traffic class, Label. Filter selection rules by Label and Traffic class fields. Analysis of MPLS. Top LSPs (with Network search option).
XGENIUS.WIRE	Wiremap with open and short circuit detection. Measurement of distance to fault. Crossover / straight cable detection. Measurement of cable skew.
XGENIUS.POE	PoE / PoE+ end point and pass through as per IEEE 802.3af and IEEE 802.3at with voltage and current measurement.
XGENIUS.ASYM	Enables separated measurement of upstream and downstream performance for RFC 2544 (measurement of throughput, latency, frame loss and back-to-back frames) and eSAM (measurement of the IR, FTD, FDV, FLR and Availability). Enables responder operation in asymmetric RFC 2544 and eSAM tests.
XGENIUS.CAPT	Captures Ethernet and IP traffic in endpoint and pass-through modes. Includes hardware frame time stamping and filtering. Allows synchronization of capture time stamps with external clock input available in the unit.

Table 8. Ethernet testing

Code	Description
XGENIUS.61850	Identifies and analyses IEC 61850 GOOSE and SV streams providing latency, jitter and frequency statistics about the selected streams. Enables GOOSE and SV filters for custom analysis of IEC 61850 data streams.

Table 8. Ethernet testing

Code	Description
XGENIUS.E1	ITU-T G.703 2048 kb/s testing including BNC and RJ48 connectors, Single port E1 generation and analysis; ITU-T G.704 frame structure with or without CRC and with or without CAS; internal, recovered and external clock references; CAS ABCD bits generation and analysis; FAS / NFAS analysis; E1 frame occupation map; frequency and received power level measurements; G.821, G.826 and M.2100 performance analysis; round trip delay measurement; service disruption time test.
XGENIUS.T1	ANSI T1.102 1544 kb/s testing over RJ-48 connector. Single port T1 generation and analysis; ANSI T1.403 SF (D4) and ESF frame structures with robbed bit generation and analysis; FDL signaling channel; internal, recovered and external clock references; T1 frame occupation map; frequency and received power level measurements; G.821, G.826 and M.2100 performance analysis; round trip delay measurement; service disruption time test.
XGENIUS.DATA	DTE / DCE emulation and datacom monitor modes. V24 / V.28 (RS-232) asynchronous and synchronous interfaces, X.21 / V.11 (RS-422) asynchronous and synchronous, V.35, V.36 (RS-449), EIA-530 and EIA-530A.
XGENIUS.C3794	Dual port IEEE C37.94 generation and analysis including IEEE C37.94 frame structure; internal, recovered and external clock references; frequency measurements; bit error ratio tests, G.821 performance analysis, anomaly and defect reports, round trip delay measurement, service disruption time test. Optical fibers and SFPs not included.
XGENIUS.E0	Generation and analysis in ITU-T variable bit rate co-directional, contra-directional and centralized interfaces including internal, recovered and external clock references; frequency measurements; bit error ratio tests; G.821 performance analysis; round trip delay measurement; service disruption time.
XGENIUS.VF	Generation and analysis of voice frequency tests, including frequency, level, noise, round trip delay and frequency sweep analysis.
XGENIUS.PULSE	Displays the pulse shape and checks compliance with ITU-T G.703 mask. Includes eye diagram operation mode and analysis of pulse time and level metrics.
XGENIUS.VFD	Enables latency tests in VF interfaces.
XGENIUS.OWD	Measures end-to-end, one-way delay in ITU-T G.703 2048 kb/s, ANSI T1.102 1544 kb/s, IEEE C37.94, Datacom and VF interfaces. This test runs between two ports in the same unit (E1, T1 IEEE C37.94) or between two compatible test units to be installed in at the ends of the transmission path to be measured (all interfaces).
XGENIUS.DUALTDM	Provides dual port traffic generation / analysis and bi-directional pass-through capabilities for ITU-T G.703 2048 kb/s or ANSI T1 102 1544 kb/s port. Plug-in module PHM24 included.

Table 9. TDM and Datacom testing

Code	Description
XGENIUS.SET	Synchronization testing according to ITU-T G.8261, G.8262, G.8264. Ethernet line frequency (MHz), offset (ppm), drift (ppm/s). Analysis / Generation of ESMC messages. SyncE clock reference inputs. Synchronous Ethernet TIE / MTIE / TDEV measurement. Synchronous Ethernet wander generation.
XGENIUS.PTPT	PTP master and slave emulation. PTP passive monitoring. PTP message classification and analysis. PDV analysis. PTP time interval error (TIE), maximum TIE (MTIE) and time deviation TDEV measurement. Floor delay population test. Time error (TE), maximum Time Error and path asymmetry test.

Table 10. Synchronization testing

Code	Description
XGENIUS.PTPT.ADV	Boundary Clock and Transparent clock test (simultaneous PTP master and slave emulation in one unit), Slave Clock test (simultaneous PTP master emulation and clock analysis in one unit), Dual Slave Emulation test with relative Time Error (TE) measurements between both test ports.
XGENIUS.NTPT	Network Time Protocol test. NTPv3 / NTPv4 server and client emulation. NTP traffic filtering, classification and analysis. NTP delay, asymmetry and Time Error (TE) statistics.
XGENIUS.JW	Peak-to-peak jitter, RMS jitter, max. jitter, jitter hits detection. Configuration of jitter filters. Frequency offset (ppm), frequency drift (ppm/s). Wander metrics (TIE, MTIE, TDEV). Sinusoidal jitter and wander generation.
XGENIUS.CLK	1544 kHz, 2048 kHz, 5 MHz, 10 MHz, 1 PPS, 1PP2S and ToD clock monitoring. Clock TE / TIE / MTIE / TDEV analysis, frequency (Hz), frequency offset (ppm) and frequency drift (ppm/s) analysis, jitter / wander analysis.
XGENIUS.OCXO	OCXO time reference. High performance internal oscillator replacing the standard time reference installed in the application board.
XGENIUS.RB	Rubidium time reference. Atomic (Rubidium) internal oscillator replacing standard time reference installed in the application board.
XGENIUS.REF	Adds GPS / GLONASS / Beidou / Galileo RF interface (SMA connector), REF IN, REF OUT additional clock reference inputs (SMB connector), REF IN / OUT additional clock reference (RJ-48 connector) and PPS IN additional test input (SMB connector) . Provides absolute time reference required by one-way latency measurements and TDM, Synchronous Ethernet and IEEE 1588v2 synchronization tests. Provides hardware support for additional clock test signals.
XGENIUS.REF.ADV	Adds multi-band GPS / GLONASS / Beidou / Galileo / Navic RF interface (SMA connector), REF IN, REF OUT additional clock reference inputs (SMB connector), REF IN / OUT additional clock reference (RJ-48 connector) and PPS IN additional test input (SMB connector) . Provides absolute time reference required by one-way latency measurements and TDM, Synchronous Ethernet and IEEE 1588v2 synchronization tests. Provides hardware support for additional clock test signals.
XGENIUS.REF.IRIGB	Adds to the clock reference inputs and outputs list the IRIG-B balanced (unmodulated, Manchester encoded) and unbalanced (modulated, unmodulated, Manchester encoded) interfaces.
XGENIUS.IRIGB	IRIG-B00X, B12X, B13X, B14X, B15X, B22X monitoring. Balanced and unbalanced inputs. Includes IRIG-B frame analysis, TE / TIE / MTIE / TDEV analysis, frequency offset (ppm) and frequency drift (ppm/s) analysis.

Table 10. Synchronization testing

Code	Description
VNC.RC	Based on VNC for Windows and Linux. Ethernet / IP remote control that duplicates the tester graphical user interface in a remote computer.
AT.WIFI.RC	Provides WiFi interconnection to the management interface in accordance with IEEE 802.11g, IEEE 802.11b and IEEE 802.11n standards.
SNMP.RC	Allows user to control the tester remotely using SNMP queries.

Table 11. Accessories

