

AQ2200 Series

Multi Application Test System

Multi Application Test System



Ideal Measurement Solution for Optical Devices and Optical Transmission Systems

- **A broad lineup of measurement modules**
Light sources, Tunable laser sources, Optical power meters, Optical attenuators, Optical switches, etc.
- **Macro programming Function**
Convenient solution for automated measurements eliminating need for an external PC controller.
- **Remote interfaces : GP-IB, Ethernet, and USB**
- **Hot-swappable modules**

For more information, go to
tmi.yokogawa.com
 Test & Measurement Instruments



Ideal Measurement Solution for Optical Devices and Optical Transmission Systems

The AQ2200 Multi Application Test System is the ideal system for measuring and evaluating a wide range of optical devices and optical transmission systems. A variety of measurement modules are available, including the following: high output level stability light sources, grid tunable laser sources, high-speed optical sensors, high-resolution and high-speed variable optical attenuators and optical transceiver interfaces. These modules can be installed in any combination on a single platform, providing an ideal measurement system for a variety of applications.

The AQ2200 Multi Application Test System is available in two different frame controller platforms. Each model has a certain number of slots for housing modules, so you can select the best platform size for your measurement application.

Frame and Module Lineup

Frame Controller

AQ2211	Frame controller (3 slots)
AQ2212	Frame controller (9 slots)

Light Source

AQ2200-112	LS module (DFB, 1/2 channels)
AQ2200-131	Grid TLS module (C/L band, 1 channel)
AQ2200-132	Grid TLS module (C/L band, 2 channels)

Optical Sensor

AQ2200-212	Sensor module
AQ2200-222	Dual sensor module (2 channels)
AQ2200-215	Sensor module (high power +30 dBm)
AQ2200-232	Optical sensor head (long wavelength)
AQ2200-242	Optical sensor head (short wavelength)
AQ2200-202	Interface module (2 channels)

Optical Attenuator (ATTN)

AQ2200-312	ATTN module (standard)
AQ2200-332	ATTN module (built-in monitor power meter)

Optical Switch (OSW)

AQ2200-421	OSW module (1x2/2x2, 2 channels)
AQ2200-411	OSW module (1x4/1x8)
AQ2200-412	OSW module (1x16)

Optical Transceiver Test

AQ2200-642	Transceiver interface module
------------	------------------------------

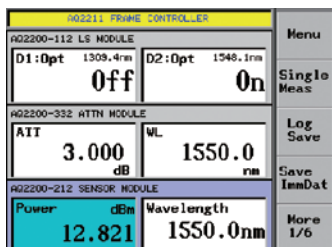

AQ2211 Frame Controller Screen (SUMMARY)

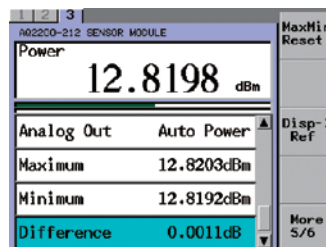

AQ2211 Frame Controller Screen (DETAIL)

Frame controller with convenient functions

◆Hot-swappable

Measurement modules can be inserted or removed without turning off the power. This hot-swapping capability makes it easier to reconfigure your system.

◆USB storage

The USB makes it easy to quickly save and load data. It saves measurement data in CSV and a screen shot in bmp, so that they can easily be imported into almost any PC application.

◆Multi user function

Up to 5 users can access to the same frame controller simultaneously.

This function contributes to cost-saving and space-saving by sharing a frame.

◆Various remote interfaces

The AQ2211 and AQ2212 frame controllers are equipped with not only IEEE488.2 compliant GP-IB but also Ethernet and USB for remote operation.

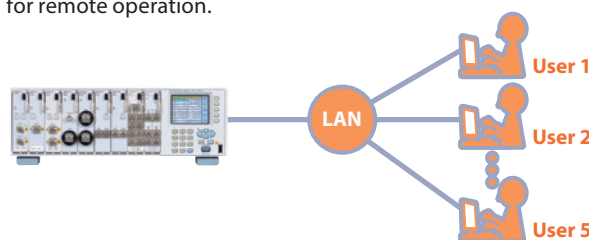

Image of Multi user function

Powerful Features for Automated Testing

Macro Programming Function

A macro program function makes it easy to build a simple automated measurement system by writing a series of operations in a program, setting measurement conditions, changing test configurations in combination with multiple modules, executing measurements, and saving results.

Step 1: Create a macro program using Macro editor, a PC application software.

Step 2: Install the macro program into Frame controller via GP-IB, Ethernet, or USB.

Step 3: Execute the macro program on the frame controller.

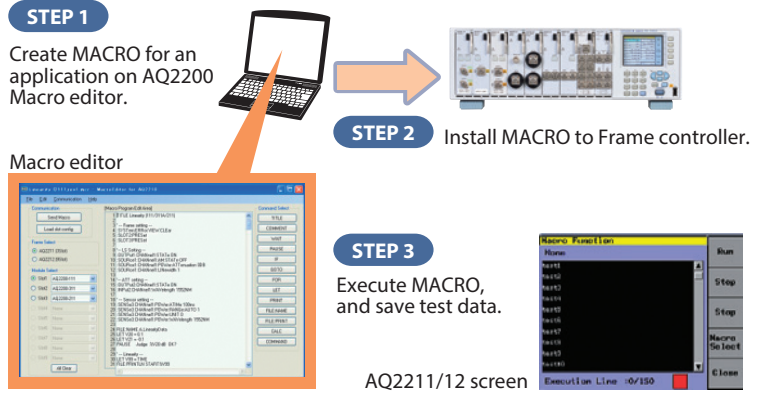

*The Macro editor (free software) can be downloaded from our web site.

Remote Viewer Software

The remote viewer software, a free PC application software, enables the AQ2200 Multi-Application Test System to be controlled from your PC via the Ethernet interface. When starting the software and setting up the connection properly, the front panel image of the connected frame controller is displayed on your PC monitor. Using a mouse, you can control the remote frame controller from your PC through operations that are similar to those for the front panel keys of the instrument. It is useful in case that you cannot see or operate the frame being mounted high up in the test stand.

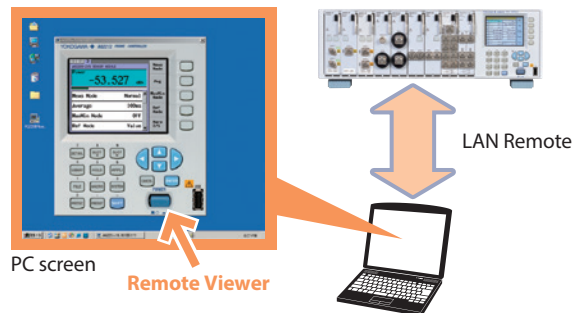

*The remote viewer software (free software) can be downloaded from our web site.

Stability / Logging Function

Stability and logging measure fluctuation in optical power.

Stability Measurement

By measuring the optical signal over a long period of time, you can check the optical power stability up to 99days.

Logging Measurement

By measuring an optical signal that fluctuate over very short periods of time, you can check the transient fluctuation or response with min. 100 μ s intervals.

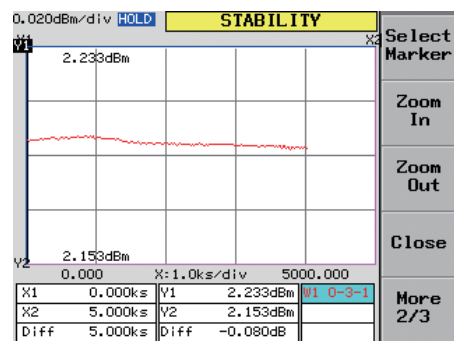

Graph Display Screen

Module Lineup

Light Source Ideal Reference Light Sources for Optical Device Measurements

LS Module (AQ2200-112)

- Laser type: DFB-LD
- Wavelength: 1310, 1550, 1625 or 1650 nm
- 1 channel or 2 channels
- Optical output level: +10 dBm or more
- Output level stability: ± 0.005 dB or less

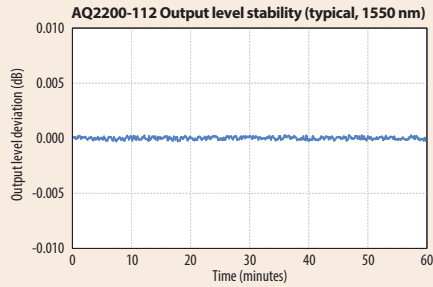

Grid Tunable Laser Source (AQ2200-131/-132)

- Frequency (Wavelength) range: C/L-band
- 1 and 2 channel modules
- Grid spacing: min. 25 GHz (0.2 nm) and manual (0.1 GHz)

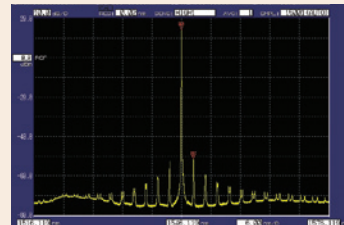

Optical spectral example (1550 nm)

Optical Sensor Improved measurement throughput

Standard Sensor (AQ2200-212)

- Single channel model with analog output port
- Wavelength range: 800 to 1700 nm
- Uncertainty: $\pm 2.5\%$
- Power range: -90 to +15 dBm
- Averaging time (min.): 100 μ s



Dual Sensor (AQ2200-222)

- Compact: Two high-performance sensors in a module.
- Wavelength range: 800 to 1700 nm
- Uncertainty: $\pm 2.5\%$
- Power range: -90 to +15 dBm
- Averaging time (min.): 100 μ s



High-Power (AQ2200-215)

- High power measurement: +30 dBm
- Wavelength range: 970 to 1660 nm
- Power range: -70 to +30 dBm
- Averaging time (min.): 100 μ s



Optical Sensor Head (AQ2200-232/-242)

- Large-diameter sensor head for free-space measurement
 - Free space measuring system can be constructed easily by supporting cage system
 - Large-diameter PD enables multi-core connector and cable measurement
- Excellent uncertainty
- High stability by temperature control
- Averaging time: 100 μ s (minimum sampling intervals)
- Two sensor heads can be connected to the AQ2200-202 Interface Module

[AQ2200-232]

- Detector: InGaAs 5 mm dia,
- Wavelength range: 800 to 1700 nm
- Power range: -90 to +15 dBm
- Uncertainty: $\pm 1.8\%$

[AQ2200-242]

- Detector: Si \square 5.8 mm
- Wavelength range: 400 to 1100 nm
- Power range: -90 to +10 dBm
- Uncertainty: $\pm 2.5\%$



*An AQ2200-202 Interface module is required.

Multicore connector adapter (AQ9340 / AQ9436C / AQ9440C)

MPO Connector Adapter (AQ9340)

- Applicable connector: 12-fiber or 24-fiber (AQ9340-12) 16-fiber or 32-fiber (AQ9340-16)
- Applicable sensor: AQ2200-232 and AQ2200-242
- Compatible with both with and without guide pins



Ribbon Fiber Adapter (AQ9436C)

- Adapter for a ribbon fiber folder of fusion splicer.
- Fiber count: 2, 4, 8 and 12 fibers
- Applicable sensor: AQ2200-232 and AQ2200-242



MT Connector Adapter (AQ9440C)

- Fiber count: 2, 4, 8, 12 and 24 fibers
- Applicable sensor: AQ2200-232 and AQ2200-242



Optical Attenuator Providing low insertion loss and fast control

One-Channel (AQ2200-312)

- Low insertion loss: 1.0 dB (typ.)
- Wide attenuation range: 0 to 60 dB (in steps of 0.001 dB)
- Monitor output (optional)
- Low polarization dependence loss: 0.1 dBp-p or less
- SMF (10/125 μm) or MMF (50/125 μm or 62.5/125 μm)



One-Channel (AQ2200-332)

- Built-in monitor power meter
- Attenuation accuracy: within ± 0.1 dB
- The output monitor function allows for directly setting the optical power
- SMF (10/125 μm) or MMF (50/125 μm or 62.5/125 μm)
- Built-in optical shutter: 90 dB or more



Optical Switch Superior switching reproducibility

1x2, 2x2 Dual Optical Switch (AQ2200-421)

- Compact: Two optical switches in a one-slot size module
- SMF (10/125 μm) or MMF (50/125 μm or 62.5/125 μm)
- Low insertion loss: 1.0 dB (typ.)
- Switching reproducibility: ± 0.01 dB



1x4, 1x8 Optical Switch (AQ2200-411)

- SMF (10/125 μm) or MMF (50/125 μm or 62.5/125 μm)
- Switching reproducibility: ± 0.01 dB
- Low insertion loss: 1.0 dB (typ.)



1x16 Optical Switch (AQ2200-412)

- SMF (10/125 μm) or MMF (50/125 μm)
- Switching reproducibility: ± 0.01 dB
- Low insertion loss: 1.0 dB (typ.)



Optical Transceiver Test Simplifying 10G transceiver test environment

Transceiver I/F module (AQ2200-642)

- Compatible with XFP, SFP+, XENPAK, etc.
- Power supply and current monitor
- I²C/MDIO interfaces
- Control signal transmission
- Status signal monitor
- Resistance value monitor



Measurement Applications

Optical Fiber Amplifier Measurement System

An optical fiber amplifier is an indispensable device for WDM transmission systems. This measurement system characterizes gains and noise figures (NF) of the fiber amplifier by measuring input light to an optical fiber amplifier, which was multiplexed using multiple light sources, as well as amplified output light with an optical spectrum analyzer. A high-power sensor allows for measuring total output power.

[Measurement items]

- Gain, NF, and total output power

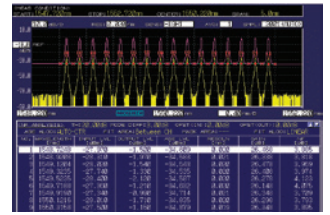

AQ6370D Measurement Screen

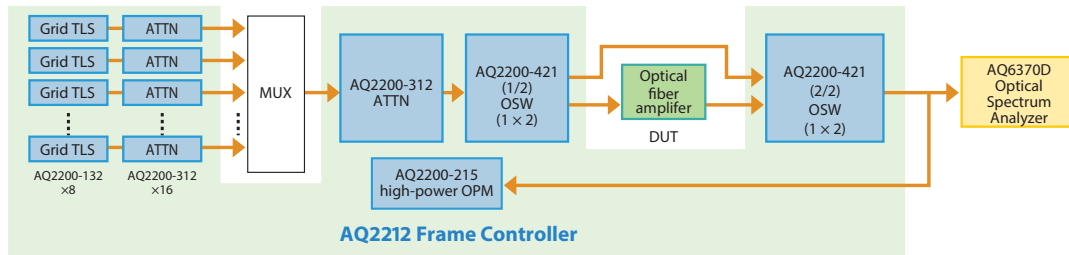

Transceiver Measurement System

The 10Gbit/s optical transceiver modules such as XFP or SFP+ are frequently used in transmission systems and Ethernet systems. The measuring system for such modules requires many instruments including controller, power supplies and multi-meters to control optical transceiver modules.

The AQ2200 Multi Application Test System allows for building a space saving test system with a variety of plug-in modules.

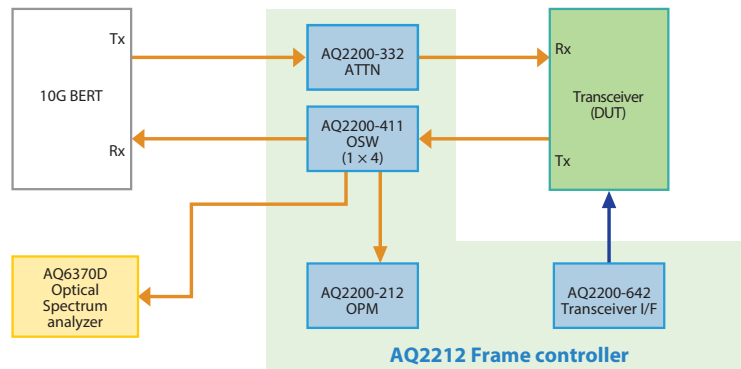

GE-PON Test System

To evaluate GE-PON systems used for FTTH networks, optical characteristics and IP traffic tests are performed. Since a GE-PON consists of OLTs and multiple ONUs, efficient measurement of multiple ports is required. Utilizing the multiple port AQ2200-4xx optical switch makes it possible to build an efficient automated

measurement system by distributing the signal in a custom test network. Since the AQ2200-332 Optical Attenuator is equipped with a monitor power meter, the ONU optical receiving level can be adjusted without changing the fiber connection.

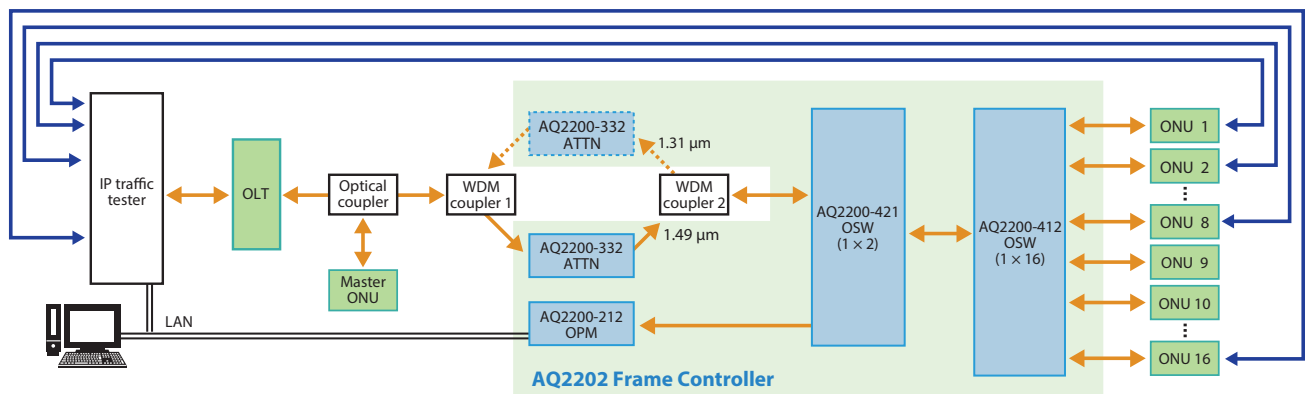

3-wavelength Optical Filter Measurement System for GE-PON

A 3-wavelength optical filter for GE-PON splits 1490 nm and 1550 nm optical signals, and pass a 1310 nm optical signal in the return direction.

This measurement system measures the insertion losses of wavelengths passing between ports and the isolation of wavelengths blocked.

[Measurement items]

- Insertion loss: (1) to (2) 1490 nm, (1) to (3) 1550 nm, (2) to (1) 1310 nm
- Isolation: (1) to (2) 1550 nm, (1) to (3) 1490 nm, (2) to (3) 1310 nm

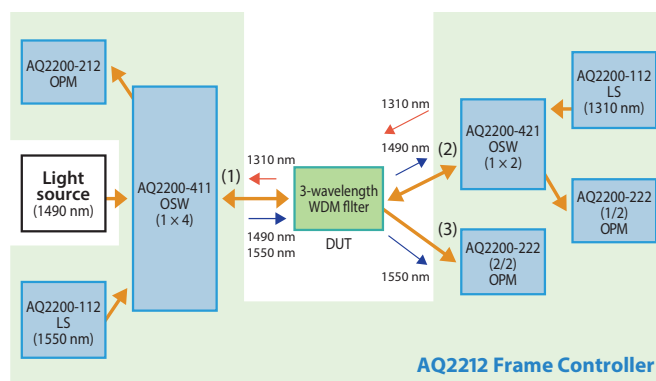

I-L curve of LD module

The I-L curve, drive current – optical power characteristics, of laser diodes can be measured accurately, quickly and seamlessly. Because, the single-range power range of an optical sensor and sensor head is as wide as 30 dB. It enables to measure signals close to a threshold value at high resolution without changing the gain of amplifier circuit which takes extra time.

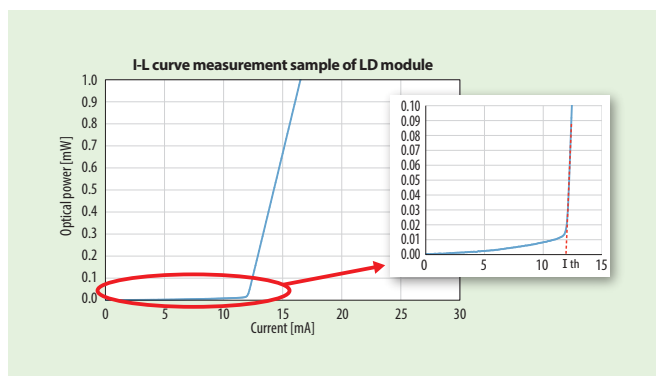

Multicore fiber loss measurement

MPO connector adapter, MT connector adapter and ribbon fiber adapter enable the measurement of the multi-fiber output directly.

With the optical switch module, a multi-fiber loss measurement system can be easily configured.

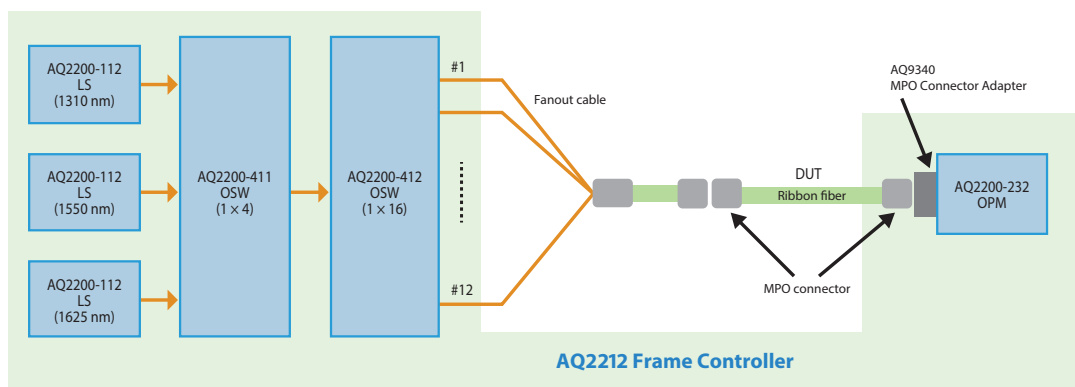

Free-space optics experiment system

In experiments of free-space optics, optical devices are set on an optical bench or a breadboard, and the adjustment of optical alignment is most time consuming work.

The optical sensor head AQ2200-232/-242 is compatible with the 60 mm cage system. It make it easy to build a optical experiment systems by combining with various cage system parts in the marketplace.

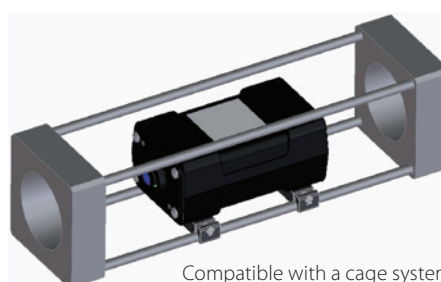

Compatible with a cage system

Product Specifications

Frame Controller (AQ2211/2212)

Items		Specifications	
Product name		A2211	AQ2212
Number of slots		3	9
Display ^[*1]		Color LCD, 320 × 240 dot	
Remote interface	GPIO	IEEE-488 compatible, protocol: IEEE-488.2 compatible	
	Ethernet	IEEE802.3 compatible, connector: RJ-45 × 1, transmission method: Ethernet (100BASE-TX), protocol: TCP/IP	
	USB	USB Rev1.1 compatible, connector: USB type B × 1, protocol: USB-TMC	
External storage interface		USB (USB Rev2.0 compatible, connector: USB type A × 1, applicable device: USB mass storage class flash memory)	
Interlock connector		BNC connector	
Functions	Preset applications	Stability, Logging, Swept, Optical return loss (ORL)	
	Control functions	Macro programming, Multi-user, Remote viewer support	
Operation environment	Ambient temperature	5 to 40°C	
	Ambient humidity	20 to 80% RH (no condensation)	
Storage environment	Ambient temperature	-20 to 60°C	
	Ambient humidity	20 to 80% RH (no condensation)	
Power requirement		100 to 240 Vac, 50/60 Hz	
Power Consumption (including modules)		170 VA	580 VA
Dimension (excluding protrusions)		Approx. 212 (W) × 132.5 (H) × 400 (D) mm	Approx. 425 (W) × 132.5 (H) × 500 (D) mm
Mass		Approx. 6 kg	Approx. 11 kg
Recommended calibration period		1 year (include modules)	

[*1] The LCD may include a few defective pixels (within 0.004% over the total number of pixels including RGB).

LS Module (AQ2200-112)

Items		Specifications	
Number of channel		1 or 2 channels	
Device type		DFB-LD	
Center Wavelength		1310 nm ± 5 nm, 1550 nm ± 5 nm, 1625 nm ± 5 nm, 1650 nm ± 5 nm	
Optical output level		+10 dBm or more	
Output level stability (5 minutes)		±0.005 dB	
Spectral linewidth		Narrow: 10 MHz (typ.) Wide: 100 MHz (typ.)	
SMSR		35 dB or more	
RIN		-135 dB/Hz (typ.)	
Attenuation range		6 dB (resolution 0.01 dB (typ.))	
Fiber type		SMF (ITU-T G.652)	
Optical connector		FC/Angled PC	
Laser safety standard class		Class 1 (IEC60825-1:2014), Class 1 (EN 60825-1:2014+A11:2021)	

● Laser Safety Information

This laser light source is a Class 1 laser product as defined by IEC 60825-1:2014 Safety of Laser Products—Part 1: Equipment Classification and Requirements. In addition, this instrument complies with 21 CFR 1040.10 and 1040.11 except for conformance with IEC 60825-1 Ed.3., as described in Laser Notice No. 56, dated May 8, 2019.

Laser class 1 label
Avoid direct eye exposure.



Grid TLS Module (AQ2200-131/-132)

Items		Specifications	
Number of channel		AQ2200-131: 1, AQ2200-132: 2	
Device type		Advanced type (-T6)	
Frequency band		C-Band	L-Band
Frequency (Wavelength) range		196.25 to 191.50 THz (1527.60 to 1565.50 nm)	190.95 to 186.35 THz (1570.01 to 1608.76 nm)
Grid spacing		100 GHz, 50 GHz, 25 GHz and Manual (min. 0.1 GHz)	
Frequency (Wavelength) setting resolution		0.1 GHz (0.8 pm@1550 nm)	0.1 GHz (0.8 pm@1590 nm)
Frequency (Wavelength) fine turning range		±6 GHz (typ.) (±48 pm@1550 nm)	±6 GHz (typ.) (±51 pm@1590 nm)
Absolute frequency (Wavelength) accuracy		±2.5 GHz (±20 pm@1550 nm)	±2.5 GHz (±21 pm@1590 nm)
Frequency (Wavelength) stability (@24 hours, ±0.5°C)		±0.3 GHz (typ.) (±2.4 pm@1550 nm)	±0.3 GHz (typ.) (±2.5 pm@1590 nm)
Frequency (Wavelength) tuning time		30 sec. or less	
Optical output level		+12.5 dBm or more	
Output level stability		±0.03 dB (typ.) (@24h, ±0.5°C)	
Attenuation range		6 dB (resolution: 0.01 dB (typ.))	
Spectral linewidth		100 kHz (typ.)	
SMSR		45 dB (typ.)	
RIN		-145 dB/Hz (typ.)	
Applicable optical fiber		PANDA PMF (Slow axis, in line with connector key)	
Optical connector		Select any of FC/PC or FC/Angled PC	
Laser safety standard class		Class 1M (IEC 60825-1:2007, GB 7247.1-2012), Class 1 (EN 60825-1:2014+A11:2021)	

● Laser Safety Information

This laser light source is classified into "IEC60825-1: 2007; Class 1M". This specification complies with "21CFR 1040.10" except for deviation points arising from strict observation of "Laser Notice No. 50" issued on June 24, 2007.

Laser class 1M label

Using an optical instrument, such as a loupe, magnifying glass, or microscope, when observing the laser beam from a distance of less than 100 mm may cause eye injury.

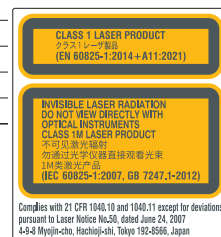

*For details, please refer to the Data sheet (AQ2200-21EN Data sheet).

Sensor Module (AQ2200-212/-222/-215)

Items	Specifications		
	AQ2200-212	AQ2200-222	AQ2200-215
Product name	AQ2200-212	AQ2200-222	AQ2200-215
Number of channels	1	2	1
Detector type	InGaAs		
Wavelength range	800 to 1700 nm		970 to 1660 nm
Power range (CW light)	-90 to +15 dBm		-70 to +30 dBm
Applicable fiber	≤62.5/125 μm (GI), NA ≤0.275		
Uncertainty Under reference conditions	±2.5%		±3%
Total uncertainty	±5% ±5 pW		±5% ±2.0 nW
Polarization dependence	0.02 dBp-p (typ.)		0.03 dBp-p (typ.)
Linearity	±0.02 dB ±5 pW		±0.05 dB ±2.0 nW
Noise level	5 pW or less		2.0 nW or less
Averaging time (min.)	100 μs		
Optical connector	AQ9335C (*) connector adapter		

Optical Sensor Head (AQ2200-232/-242)

Items	Specifications	
	AQ2200-232 ^[*1]	AQ2200-242 ^[*1]
Product name	AQ2200-232 ^[*1]	AQ2200-242 ^[*1]
Number of channels	1	
Detector type	InGaAs 5 mm dia.	Si □ 5.8 mm
Wavelength range	800 to 1700 nm	400 to 1100 nm
Power range (CW light)	-90 to +15 dBm	-90 to +10 dBm
Applicable fiber	≤62.5/125 μm (GI), NA ≤0.275	
Uncertainty Under reference conditions	±1.8%	±2.5%
Total uncertainty	±5% ±5 pW	
Polarization dependence	0.025 dBp-p (typ.)	—
Linearity	±0.015 dB ±5 pW	±0.04 dB ±5 pW
Noise level	5 pW or less	
Averaging time (min.)	100 μs	
Optical connector	AQ9335C (*) connector adapter	

[*1] Have to be operated with the AQ2200-202 Interface module. Two sensor heads can be connected to the AQ2200-202.

MPO Connector Adapter (AQ9340)

Items	Specifications	
	AQ9340-12	AQ9340-16
Model name	AQ9340-12	AQ9340-16
Applicable sensor	AQ2200-232 / -242	AQ2200-242
Applicable connector	12-fiber, 24-fiber (IEC-61754-7)	16-fiber, 32-fiber
Fiber count	2, 4, 8, 12 and 24 fibers	16, 32 fibers
Applicable fiber	SM (9.5/125 μm), GI (50/125 μm)	GI (50/125 μm)

Ribbon Fiber Adapter (AQ9436C) / MT Connector Adapter (AQ9440C)

Items	Specifications	
	AQ9436C	AQ9440C
Model name	AQ9436C	AQ9440C
Applicable sensor	AQ2200-232 / -242	AQ2200-232 / -242
Fiber count	2, 4, 8 and 12 fibers	2, 4, 8, 12 and 24 fibers
Applicable fiber	SM (9.5/125 μm), GI (50/125 μm)	SM (9.5/125 μm), GI (50/125 μm)

ATTN Module (AQ2200-312/-332)

Items	Specifications			
	AQ2200-312		AQ2200-332	
Product name	AQ2200-312		AQ2200-332	
Number of channels	1			
Wavelength range	1200 to 1700 nm	800 to 1370 nm	1200 to 1700 nm	800 to 1370 nm
Insertion loss	1.0 dB (typ.) 1.6 dB or less		1.9 dB (typ.) 2.3 dB or less	
Maximum attenuation	60 dB	45 dB	60 dB	45 dB
Attenuation accuracy	±0.1 dB or less			
Repeatability	±0.01 dB or less			
Output monitor accuracy	—		±5% or less	
Optical return loss (with PC connector)	45 dB or more	20 dB or more	45 dB or more	20 dB or more
Polarization dependence	0.08 dBp-p or less	—	0.1 dBp-p or less	—
Maximum input power	+23 dBm	—	+23 dBm	—
Shutter isolation	90 dB or more			
Applicable optical fiber	SMF (ITU-T G.652)	MMF (GI 50/125) (ITU-T G.651.1) or MMF (GI 62.5/125) (IEC 60793-2)	SMF (ITU-T G.652)	MMF (GI 50/125) (ITU-T G.651.1) or MMF (GI 62.5/125) (IEC 60793-2)
Optical connector	FC/PC or SC/PC			
Monitor port option	Monitor port output	-13 dB (typ.)		
	Insertion loss	2.3 dB or less		
	Polarization dependence	0.1 dBp-p or less	—	

*For details, please refer to the Data sheet (AQ2200-21EN Data sheet).

Product Specifications

OSW Module (AQ2200-411/-412)

Items	Specifications				
	AQ2200-411				AQ2200-412
Product name					
Port configuration	1 × 4	1 × 8	1 × 4	1 × 8	1 × 16
Number of switch	1				
Wavelength	1310 nm/1550 nm		850 nm/1310 nm		1310 nm/1550 nm 850 nm/1310 nm
Insertion loss	1 dB (typ.) 1.4 dB or less				
Repeatability	±0.01 dB or less				
Crosstalk	-60 dB or less		-50 dB or less		-60 dB or less -50 dB or less
Optical return loss	45 dB or more		20 dB or more		45 dB or more 20 dB or more
Polarization dependence	0.08 dBp-p or less		—		0.08 dBp-p or less —
Applicable optical fiber	SMF (ITU-T G.652)		Select any of MMF (GI 50/125) (ITU-T G651.1) or MMF (GI 62.5/125) (IEC 60793-2)		SMF (ITU-T G.652) MMF (GI 50/125) (ITU-T G651.1)
Optical connector	Select any of FC/PC or SC/PC				

OSW Module (AQ2200-421)

Items	Specifications			
	AQ2200-421			
Product name				
Port configuration	1 × 2	2 × 2	1 × 2	2 × 2
Number of switch	2			
Wavelength	1310 nm/1550 nm		850 nm/1310 nm	
Insertion loss	1 dB (typ.) 1.4 dB or less			
Repeatability	±0.01 dB or less			
Crosstalk	-50 dB or less			
Optical return loss	45 dB or more		20 dB or more	
Polarization dependence	0.08 dBp-p or less		—	
Applicable optical fiber	SMF (ITU-T G.652)		Select any of MMF (GI 50/125) (ITU-T G651.1) or MMF (GI 62.5/125) (IEC 60793-2)	
Optical connector	Select any of FC/PC or SC/PC			

Transceiver I/F Module (AQ2200-642)

● Monitoring Specifications

Items		Rating		Measurement Range			Accuracy
		Upper	Lower	Upper	Lower	Resolution	
Power supply voltage monitor	PS1	+7.5 V	-0.5 V	+6 V	+2 V	1 mV	±(0.2% of reading + 1 mV)
	PS2	+7.5 V	-0.5 V	+4 V	+2 V		
	PS3	+7.5 V	-0.5 V	+2.5 V	+0.5 V		
	PS4	-7.5 V	+0.5 V	-2 V	-6 V		
	PS5	+7.5 V	-0.5 V	+6 V	+2 V		
Power supply current monitor	PS1	—	—	1.8 A	0 A	1 mA	±(1% of reading + 2 mA)
	PS2			3 A	0 A		
	PS3			1.8 A	0 A		
	PS4			3 A	0 A		
	PS5			2 A	0 A		
Status signal monitor	AIN1 to AIN6	+7.5 V	-0.5 V	+6 V	+0 V	0.01 V	±(1% of reading + 20 mV)
Resistance value monitor	R1	—	—	10000 Ω	0 Ω	1 Ω	±(0.5% of reading + 2 Ω)
Power consumption monitor	PSPOWER	—	—	28 W	0 W	0.1 W	See the values for the voltage and current monitors.

● Power Supply Specifications

Name	Voltage Range	Current Limit Range
PS1	+4.750 to +5.250 V	0.10 to 1.80 A
PS2	+3.135 to +3.465 V	0.10 to 3.00 A
PS3	+0.800 to +1.890 V	0.10 to 1.80 A
PS4	-5.460 to -4.940 V	0.10 to 3.00 A
PS5	5.0 or 3.3 V	0.10 to 1.00 A (when 5.0 V is selected) 0.10 to 2.00 A (when 3.3 V is selected)

Ordering Information

AQ2211/AQ2212 Frame Controller

Model	Suffix	Descriptions
735101		AQ2211 Frame Controller
735102		AQ2212 Frame Controller
	-D	UL/CSA standard and PSE compliant, rated voltage: 125 V
	-F	VDE/Korean standard, rated voltage: 250 V
	-R	Australian standard, rated voltage: 250 V
	-Q	British standard, rated voltage: 250 V
	-H	Chinese standard, rated voltage: 250 V
	-N	Brazilian standard, rated voltage: 250 V
	-T	Taiwanese standard, rated voltage: 125 V
	-B	Indian standard, rated voltage: 250 V
	-U	IEC Plug Type B, rated voltage: 250 V

AQ2200-112 LS Module

Model	Suffix	Descriptions
AQ2200112		AQ2200-112 LS Module
	-D300	DFB-LD, 1310 nm
	-D500	DFB-LD, 1550 nm
	-D600	DFB-LD, 1625 nm
	-D700	DFB-LD, 1650 nm
	-D3D3	DFB-LD, Ch1: 1310 nm, Ch2: 1310 nm
	-D3D5	DFB-LD, Ch1: 1310 nm, Ch2: 1550 nm
	-D3D6	DFB-LD, Ch1: 1310 nm, Ch2: 1625 nm
	-D3D7	DFB-LD, Ch1: 1310 nm, Ch2: 1650 nm
	-D5D5	DFB-LD, Ch1: 1550 nm, Ch2: 1550 nm
	-D5D6	DFB-LD, Ch1: 1550 nm, Ch2: 1625 nm
	-D5D7	DFB-LD, Ch1: 1550 nm, Ch2: 1650 nm
	-D6D6	DFB-LD, Ch1: 1625 nm, Ch2: 1625 nm
	-D6D7	DFB-LD, Ch1: 1625 nm, Ch2: 1650 nm
	-D7D7	DFB-LD, Ch1: 1650 nm, Ch2: 1650 nm

AQ2200-131 Grid TLS Module

Model	Suffix	Descriptions
AQ2200131		AQ2200-131 Grid TLS Module
	-C	C-band
	-L	L-band
	-T6	Advanced type
	-PA	Optical fiber: PMF
	-FCC	Optical connector: FC/PC
	-FCA	Optical connector: FC/Angled PC

AQ2200-132 Grid TLS Module

Model	Suffix	Descriptions
AQ2200132		AQ2200-132 Grid TLS Module
	-CC	Ch1: C-band, Ch2: C-band
	-LL	Ch1: L-band, Ch2: L-band
	-CL	Ch1: C-band, Ch2: L-band
	-T6	Advanced type
	-PA	Optical fiber: PMF
	-FCC	Optical connector: FC/PC
	-FCA	Optical connector: FC/Angled PC

AQ2200-212/-222 Sensor Module

Model	Suffix	Descriptions
AQ2200212		AQ2200-212 Sensor Module
AQ2200222		AQ2200-222 Dual Sensor Module
	/FCC	AQ9335C (FC) Connector Adapter
	/SCC	AQ9335C (SC) Connector Adapter
	/LCC	AQ9335C (LC) Connector Adapter
	/MUC	AQ9335C (MU) Connector Adapter

AQ2200-215 Sensor Module

Model	Suffix	Descriptions
735125		AQ2200-215 Sensor Module
	-NON	Without optical connector adapter
	-FCC	AQ9335C (FC) Connector Adapter
	-SCC	AQ9335C (SC) Connector Adapter
	-LCC	AQ9335C (LC) Connector Adapter
	-MUC	AQ9335C (MU) Connector Adapter

AQ2200-232/-242 Optical Sensor Head

Model	Suffix	Descriptions
AQ2200232		AQ2200-232 Optical Sensor Head
AQ2200242		AQ2200-242 Optical Sensor Head
	-L1	Connection cable, length 1 m
	-L4	Connection cable, length 4 m
	/FCC	AQ9335C (FC) Connector Adapter
	/SCC	AQ9335C (SC) Connector Adapter
	/LCC	AQ9335C (LC) Connector Adapter
	/MUC	AQ9335C (MU) Connector Adapter

AQ2200-202 Interface Module

Model	Suffix	Descriptions
AQ2200202		AQ2200-202 Interface Module (for Optical Sensor Head, 2-channel)

AQ2200-312 ATTN Module

Model	Suffix	Descriptions
AQ2200312		AQ2200-312 ATTN Module
	-SA	Optical fiber: SMF
	-G5	Optical fiber: MMF (GI 50/125)
	-G6	Optical fiber: MMF (GI 62.5/125)
	-FCC	Optical connector: FC / PC
	-SCC	Optical connector: SC / PC
	/MON	Monitor port

AQ2200-332 ATTN Module

Model	Suffix	Descriptions
AQ2200332		AQ2200-332 ATTN Module
	-SA	Optical fiber: SMF
	-G5	Optical fiber: MMF (GI 50/125)
	-G6	Optical fiber: MMF (GI 62.5/125)
	-FCC	Optical connector: FC / PC
	-SCC	Optical connector: SC / PC

AQ2200-411 OSW Module

Model	Suffix	Descriptions
735141		AQ2200-411 OSW Module
	-04	Port configuration: 1 × 4
	-08	Port configuration: 1 × 8
	-SA	Optical fiber: SMF
	-G5	Optical fiber: MMF (GI 50/125)
	-G6	Optical fiber: MMF (GI 62.5/125)
	-FCC	Optical connector: FC / PC
	-SCC	Optical connector: SC / PC

AQ2200-412 OSW Module

Model	Suffix	Descriptions
735143		AQ2200-412 OSW Module
	-16	Port configuration: 1 × 16
	-SA	Optical fiber: SMF
	-G5	Optical fiber: MMF (GI 50/125)
	-FCC	Optical connector: FC / PC
	-SCC	Optical connector: SC / PC

AQ2200-421 OSW Module

Model	Suffix	Descriptions
735142		AQ2200-421 OSW Module
	-21	Port configuration: Dual 1 × 2
	-22	Port configuration: Dual 2 × 2
	-SA	Optical fiber: SMF
	-G5	Optical fiber: MMF (GI 50/125)
	-G6	Optical fiber: MMF (GI 62.5/125)
	-FCC	Optical connector: FC / PC
	-SCC	Optical connector: SC / PC

AQ2200-642 Transceiver I/F Module

Model	Suffix	Descriptions
735162		AQ2200-642 Transceiver I/F Module

Accessories

Model	Product Name	Descriptions
AQ2200901	AQ2200-901 Blank Panel	1 slot size
735182-03	Rackmount kit for AQ2211	Left-side mounting
735182-09	Rackmount kit for AQ2212	
AQ9335C-FCC	AQ9335C (FC) Connector Adapter	FC connector, for optical sensors (A light shielding cap is not included)*1
AQ9335C-SCC	AQ9335C (SC) Connector Adapter	SC connector, for optical sensors (A light shielding cap is not included)*1
AQ9335C-LCC	AQ9335C (LC) Connector Adapter	LC connector, for optical sensors (With a dust protection cap)
AQ9335C-MUC	AQ9335C (MU) Connector Adapter	MU connector, for optical sensors (With a dust protection cap)
AQ9340-12	AQ9340 MPO Connector Adapter	12-fiber or 24-fiber (IEC-61754-7)
AQ9340-16	AQ9340 MPO Connector Adapter	16-fiber or 32-fiber
AQ9436C	AQ9436C Ribbon Fiber Adapter	2, 4, 8 and 12 fibers
AQ9440C	AQ9440C MT Connector Adapter	2, 4, 8, 12 and 24 fibers
M3407HA	Light shielding cap (FC)	For FC connector
M3407HB	Light shielding cap (SC)	For SC connector
M3407HD	Dust protection cap (LC)	For LC connector
M3407HE	Dust protection cap (MU)	For MU connector

*1 When executes the ZERO-SET of optical sensors, use a light shielding cap (option).

Ethernet is a registered trademark of Xerox Corporation. All other company names and product names mentioned herein are registered trademarks or trademarks of their respective holders.

Caution



When you export this product out of Japan, permission from the Japanese government may be required in accordance with the regulations of the foreign exchange and foreign trade laws.
The information contained herein is subject to change without prior notice in order to improve performance and quality.



<https://tmi.yokogawa.com/>

YMI-N-HMI-M-E03

YOKOGAWA TEST & MEASUREMENT CORPORATION

Global Sales Dept. /E-mail: tm@cs.jp.yokogawa.com

YOKOGAWA CORPORATION OF AMERICA

YOKOGAWA EUROPE B.V.

YOKOGAWA TEST & MEASUREMENT (SHANGHAI) CO., LTD.

YOKOGAWA ELECTRIC KOREA CO., LTD.

YOKOGAWA ENGINEERING ASIA PTE. LTD.

YOKOGAWA INDIA LTD.

YOKOGAWA ELECTRIC CIS LTD.

YOKOGAWA AMERICA DO SUL LTDA.

YOKOGAWA MIDDLE EAST & AFRICA B.S.C(c)

<https://tmi.yokogawa.com/us/>

<https://tmi.yokogawa.com/eu/>

<https://tmi.yokogawa.com/cn/>

<https://tmi.yokogawa.com/kr/>

<https://tmi.yokogawa.com/sg/>

<https://tmi.yokogawa.com/in/>

<https://tmi.yokogawa.com/ru/>

<https://tmi.yokogawa.com/br/>

<https://tmi.yokogawa.com/bh/>

The contents are as of February 2024. Subject to change without notice.

Copyright © 2007, Yokogawa Electric Corporation

Copyright © 2011, Yokogawa Test & Measurement Corporation

[Ed: 11/b] Printed in Japan, 403(KP)